



ML BERT Series

Installation | Connection | Calibration | Measurement
User Manual Revision 1.1.3, August 2024



ML4039B – ML4054B – ML4039D – ML4079D – ML4039E/EN – ML4079E

Copyright © MultiLane Inc. All rights reserved. Licensed software products are owned by MultiLane Inc. or its suppliers and are protected by United States copyright laws and international treaty provisions.

Use, duplication, or disclosure by the Government is subject to restrictions as set forth in subparagraph (c)(1)(ii) of the Rights in Technical Data and Computer Software clause at DFARS 252.227-7013, or subparagraphs (c)(1) and (2) of the Commercial Computer Software -- Restricted Rights clause at FAR 52.227-19, as applicable.

MultiLane Inc. products are covered by U.S. and foreign patents, issued and pending. Information in this publication supersedes that in all previously published material. Specifications and price change privileges reserved.

General Safety Summary

Review the following safety precautions to avoid injury and prevent damage to this product or any products connected to it. To avoid potential hazards, use this product only as specified.

Only qualified personnel should perform service procedures.

While using this product, you may need to access other parts of the system. Read the General Safety Summary in other system manuals for warnings and cautions related to operating the system.

To Avoid Fire or Personal Injury

Use Proper Power Cord. Only use the power cord specified for this product and certified for the country of use.

Observe All Terminal Ratings. To avoid fire or shock hazard, observe all ratings and markings on the product. Consult the product manual for further ratings information before making connections to the product. Do not apply a potential to any terminal, including the common terminal that exceeds the maximum rating of that terminal.

Do Not Operate Without Covers.

Do not operate this product with covers or panels removed.

Avoid Exposed Circuitry. Do not touch exposed connections and components when power is present.

Do Not Operate with Suspected Failures.

If you suspect there is damage to this product, have it inspected by qualified service personnel.

Do Not Operate in Wet/Damp Conditions. Do Not Operate in an Explosive Atmosphere. Keep Product Surfaces Clean and Dry



Caution statements identify conditions or practices that could result in damage to this product or other property.

Table of Contents

Notices	2
Table of Contents	3
Revision Control	4
List of Acronyms	5
Introduction	6
GUI Introduction	7
Installation	7
Connecting to the Instrument	8
Launching the GUI	9
GUI Overview	9
BERT Configurations	10
GUI Navigation	11
Instrument Control	11
Title Tab.....	11
BERT Settings Tab.....	11
TX Control	12
TX Control in Optimal Mode.....	12
TX Control in Advanced Mode.....	13
RX Control	16
Rx Diagnostics.....	17
Clock Configuration	18
Jitter Injection	18
Supported Measurements	19
Measurement Controls	19
Generic Measurements	19
Platform Specific Measurements	22
Activating a purchased Real Hardware FEC License.....	22
Real Hardware FEC Measurements.....	23
Emulated FEC measurements.....	28
Noise Injection and Shallow Loopback Measurements.....	29
Host Interface for Module Management.....	31
BERT Characteristics	38
Appendix 1 – Adding a BERT to the Network	39
Appendix 2 – Changing the IP Address to Suit a Corporate Network	41
Changing the IP Address of the Instrument Using LaneControl.....	41
Appendix 3 – Firmware Upgrade: Step by Step Guide	43
Upgrading Firmware of the Instrument Using LaneControl.....	43

Revision Control

Revision number	Description	Release Date
1.0.0	<ul style="list-style-type: none">Initial Release	11/25/2020
1.1.0	<ul style="list-style-type: none">Added new TB Features: measurement tables, multi-channel support, new FEC measurements (BER, SER)Adapter Compliance Testing using ML4054B	07/22/2021
1.1.3	<ul style="list-style-type: none">FW UpdateIP Change	08/07/2024

List of Acronyms

Acronym	Definition
BW	Bandwidth
BERT	Bit Error Rate Tester
Conf	Configuration
DUT	Device Under Test
FEC	Forward Error Correction
FW	Firmware
GBd	Gigabaud
Gbps	Gigabits per Second
GUI	Graphical User Interface
HW	Hardware
ISI	Inter-symbol Interference
JTOL	Jitter Tolerance
NRZ	Non-Return to Zero
PAM4	Pulse Amplitude Modulation (4-level)
SI	Signal Integrity
SNR	Signal-to-Noise Ratio
Sim	Simulation
SW	Software

Introduction

The rapid growth of cloud computing economies demands the need for stable and high-speed data center interconnect solutions. With the widespread adoption of 400G – and move towards 800G and beyond – errors have become an inherent part of any HSIO system. Success now lies not only in identifying where errors occur, but also in determining which errors are critical to correct.

A key player in the test and measurement industry, MultiLane provides an essential high-value instrumentation that ensures vendors can keep up with demand and bring their designs to market. Our ThunderBERT line-up of BERTs, which covers virtually any desired line rate up to 800Gbps, offers an extensive array of diagnostic and tuning capabilities.

By generating specific signals to determine the actual bit error rate (BER) of the target channel, BERTs are mandatory instruments for communication testing. The brand new ThunderBERT GUI provides you with an intuitive and comprehensive tool to validate your designs.

In this upgraded implementation of our BERT user guide, MultiLane provides a fully revised and unified manual for the ML BERT series compatible with the ThunderBERT GUI.

GUI Introduction

To install and start using the ThunderBERT interface for the first time, follow this step-by-step installation guide (with pictures) below:

1. **Run** the ThunderBERT setup file.
2. **Install** ThunderBERT.
3. **Connect** the ML BERT to the local network.
4. **Launch** the GUI.
5. **Start** the measurements.

Installation

After downloading the ThunderBERT setup file, select run and follow this easy step-by-step installation procedure:

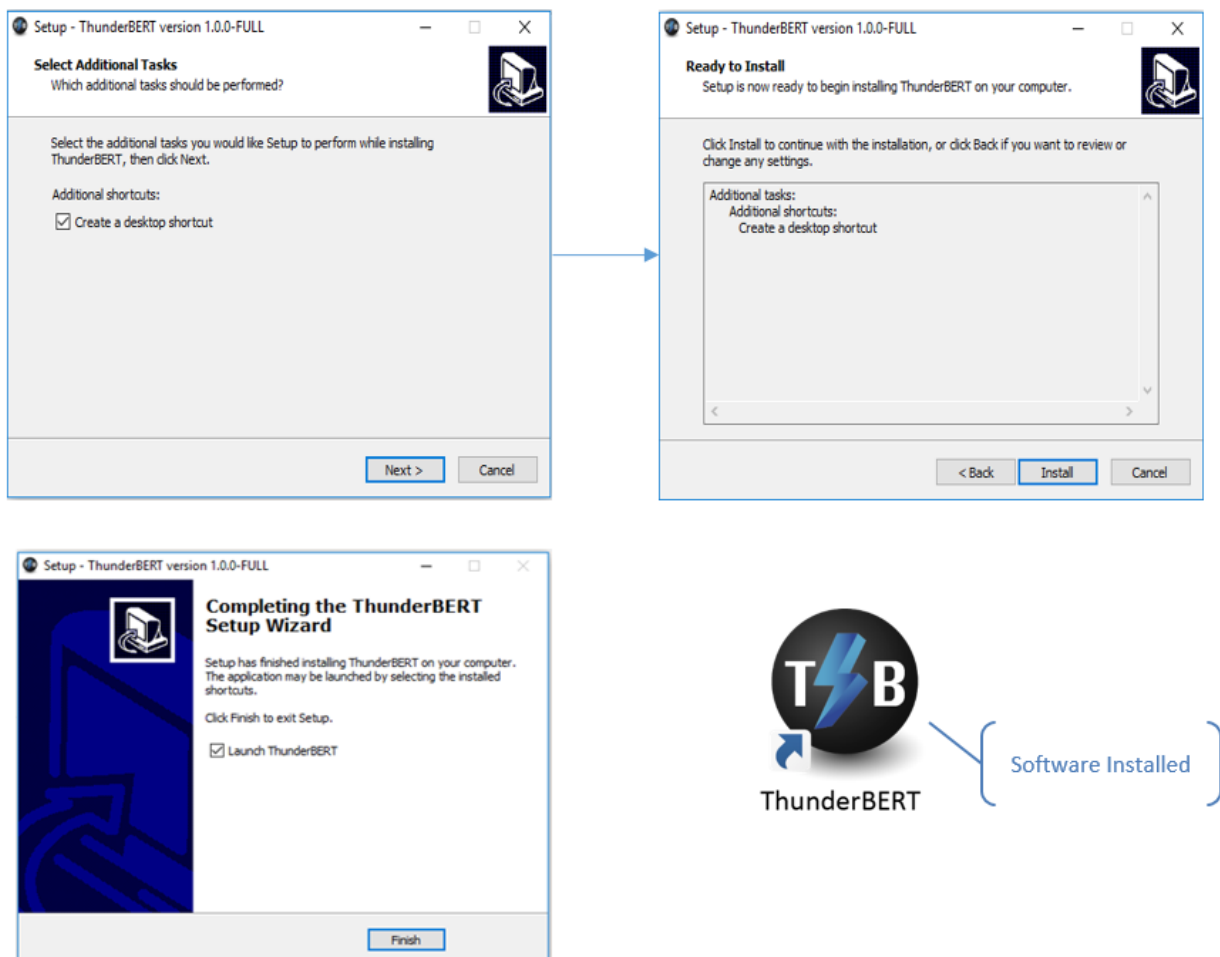

Figure 1: Setup installation procedure

ThunderBERT should now be ready to run, with a shortcut button on the Desktop.

Connecting to the Instrument

To connect to the instrument, follow this sequence of steps:

- **Install** the ThunderBERT GUI software.
- **Connect** the power cable to the power jack of the BERT and plug it into an AC outlet. *The power cable is already included in the package accessories.*
- **Power Up** the BERT.
- **Connect** the device to the network* using a RJ45/LAN cable. *LAN connections can be validated with a ping to the static instrument IP.*
- **Run** ThunderBERT software.
- **Connect** using the IP address of the target instrument (Figure 2). The IP address is printed on the back side of the BERT.

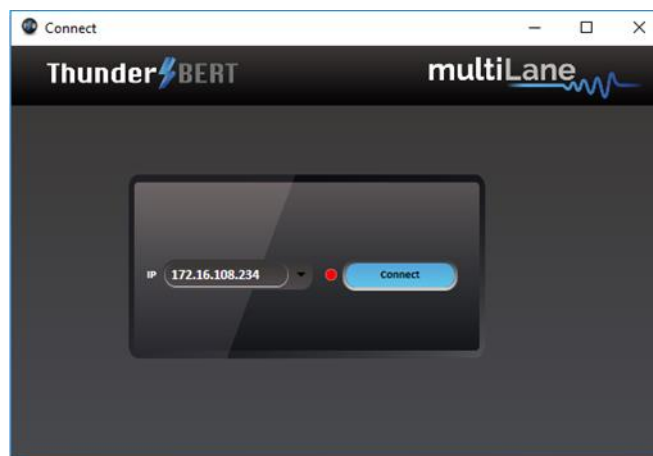

Figure 2: Connection box

NOTES:

- The previously connected IP addresses will appear in the drop-down list next to the type box.
- The red-light indicator (R) will remain red while no connection is established (Figure 2).
- In the case of a connection failure, a pop-up message will appear indicating a connection error (Figure 3).

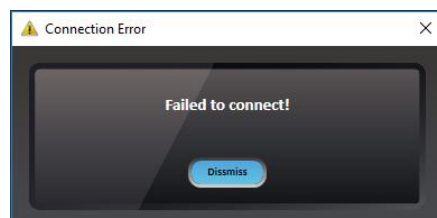

Figure 3: Connection failure notification

*To add the device to the network, consult [Appendix I](#) at the end of this manual

Launching the GUI

After establishing connection to the BERT, the GUI is initialized immediately, and all the BERT features are ready for use.

The general display of the ThunderBERT GUI will appear and you can commence testing.

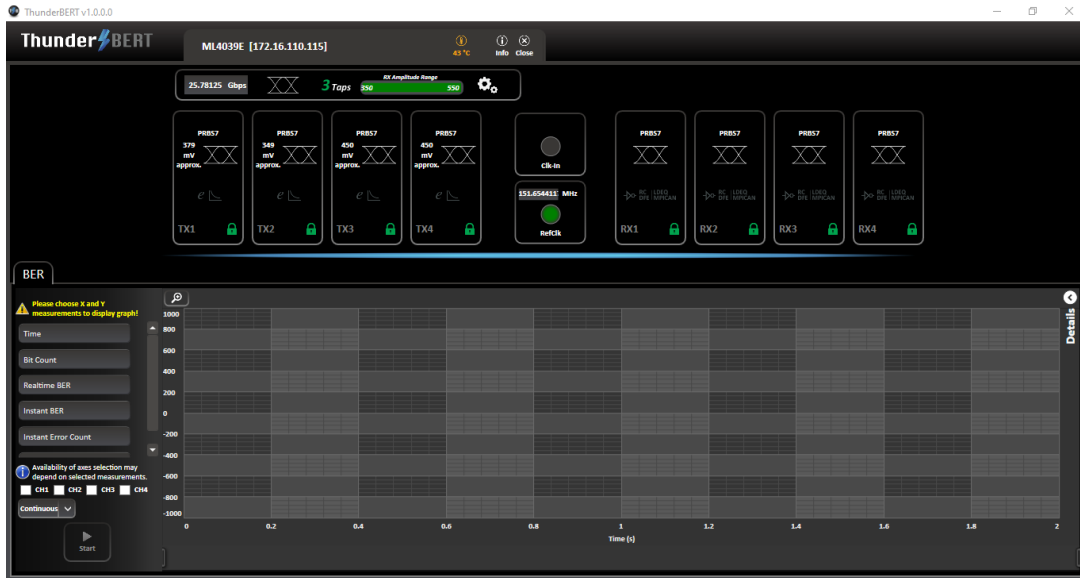

Figure 4: General GUI display (ML4039E)

GUI Overview

ThunderBERT provides end users with the ability to navigate and configure instruments from the ML BERT product family. The provision of a responsive and intuitive GUI enables you to perform different kinds of tests and measurements as well as control every aspect of the BERT platform.

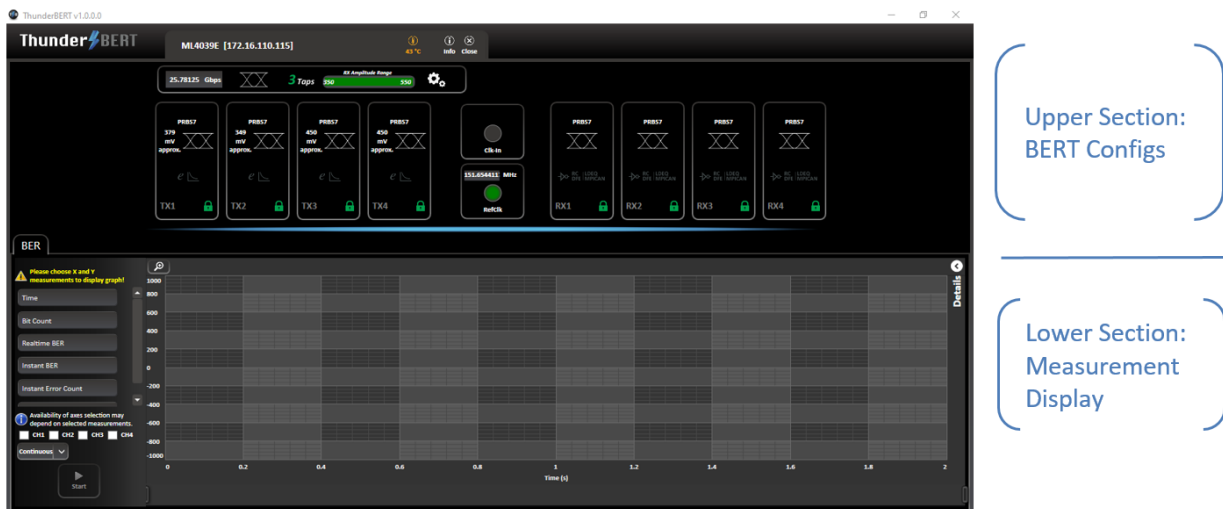

Figure 5: Segmented GUI display (ML4039E)

BERT Configurations

This section is used to parameterize BERT measurements and to control the TX/RX configurators of each channel in addition to clock rate and other common BERT settings.

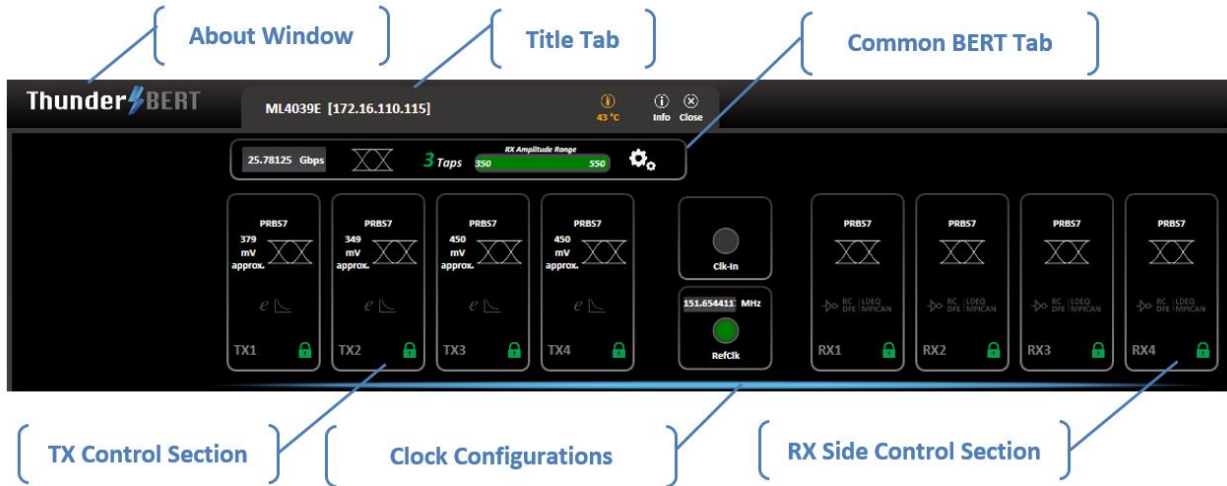

Figure 6: BERT control tab

- **About Window** (Figure 7) will give you access to the necessary information about the product including:
 - SW and API versions and Release Note
 - A link to this User Guide
 - Logs and configuration Files
- **Title Tab** contains:
 - Instrument ID, Instrument IP address, and Temperature display
 - The info tab
 - A close GUI button
- **Common BERT Settings Tab** contains:
 - Baud rate configuration
 - Signal modulation selection (NRZ/PAM4)
 - FFE tap selection (3- or 7-tap modes)
 - RX Amplitude/Sensitivity Range
 - Load + Save configuration options
- **TX Control Section Tab** contains:
 - Pattern and Amplitude control
 - Error insertion in optimal or advanced mode
- **Clock Configuration Tabs** contain clock-out and clock-in control.
- **RX-side Control Section Tab** contains:
 - RX invert, RX pattern selection and RX diagnostics
 - Equalization block

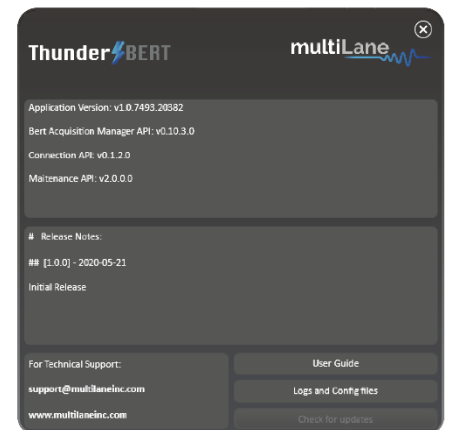

Figure 7: About window

GUI Navigation

Instrument Control



Figure 8: Title tab

Title Tab

- Displays general information of the BERT (BERT PN, instrument IP, instrument temperature).
- The device tab where all board details are displayed (Figure 9).
- Close button: disconnect from the BERT and close GUI instance (Figure 10).

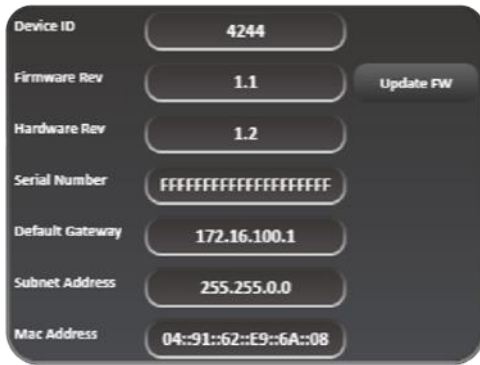

Figure 9: Device tab

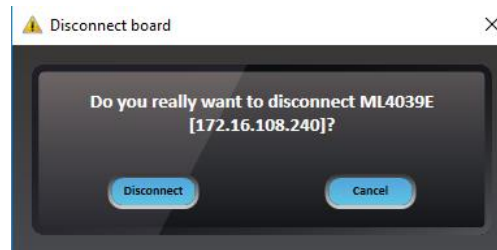

Figure 10: Disconnect popup window

BERT Settings Tab

The **BERT Settings Tab** shows all primary BERT configurations which you can set.

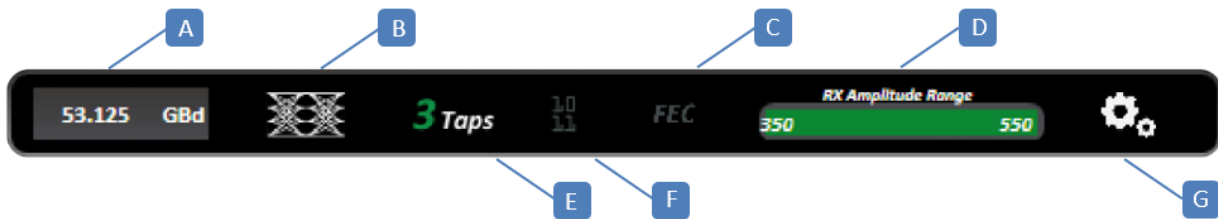

Figure 11: BERT settings tab

A: Baud rate Selection – **B:** Modulation Selection – **C:** FEC – **D:** RX Amplitude Range – **E:** FFE Tap Selection – **F:** Gray Coding Feature – **G:** Additional Options

The common **BERT Settings Tab** reflects enabled features; whenever a feature is enabled (gray coding, 3/7-tap and FEC) the corresponding button turns green as shown in Figure 12.

From this tab, select/configure to control the following features:

- **Specify the Baud rate.**
- **Specify the signal modulation type:** NRZ/PAM4 (if available/supported).
- **Enable/Disable the FEC feature.**
- **Check the Rx amplitude range** supported by the error detector.
- **Select the 3 or 7 taps FIR filter mode.**
- **Enable/Disable the gray code option.**
- **Load/Save** the configurations through the gearbox button (Figure 15).

- A
- B
- C
- D
- E
- F
- G



Figure 12: Display of enabled features

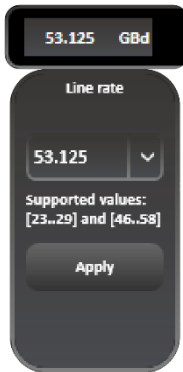

Figure 13: Set baud rate

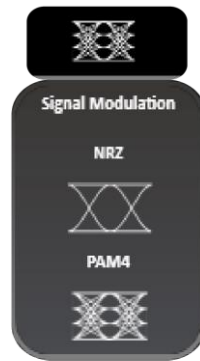

Figure 14: Signal modulation selection

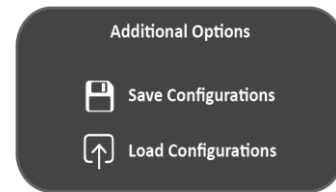

Figure 15: Additional options

NOTES:

- The 'Apply' button should be pressed after any rate change; the new line rate is set within one second (Figure 13).
- Switching between NRZ and PAM4: Modulation Type available based on the selected baud rate (Figure 14).
- Additional Options let you save and load test configurations including bit rate, pattern, signal modulation, number of taps and their values, inversion, etc., for all channels (Figure 15).

TX Control

TX Control in Optimal Mode

TX channel settings can be controlled individually. A display window reflecting all the enabled features and the applied TX settings per channel is displayed after clicking on each TX channel tab (Figure 16).

- **Enable/Disable TX control for each channel (TX ON/OFF).** Once turned off, the control of TX settings is disabled: channel control is locked from any selections, and TX output is turned off (Figure 17).
- **Specify the TX signal pattern.** The supported TX patterns are all available in the dropdown list, depending on the BERT model in use.
- **Specify the TX amplitude.** In optimal mode, the slider shows the calibrated differential eye amplitude range, each displayed value is the combination of the optimal FFE taps. Pre-Emphasis, Main, and Post-Emphasis taps are calculated during calibration.

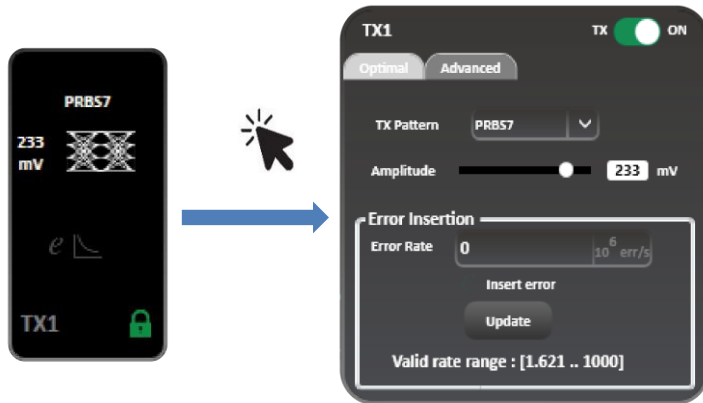

Figure 16: TX control tab and applied settings in optimal mode



Figure 17: TX OFF - channel control locked

NOTES:

Calibration is supported on low and high rates and on both eye modes (NRZ and PAM4). The optimal FFE taps are currently calculated at scaling 80%.

- **Specify Error insertion rate.** The actual rate of errors per second depends on architecture capabilities (Figure 18).

To insert Errors:

- **Enable Error Insertion mode** $e \rightarrow e$ (the green color indicates that error insertion feature is enabled).
- **Specify the Error Insertion Rate.**
- **Click** on the Update button to apply changes.

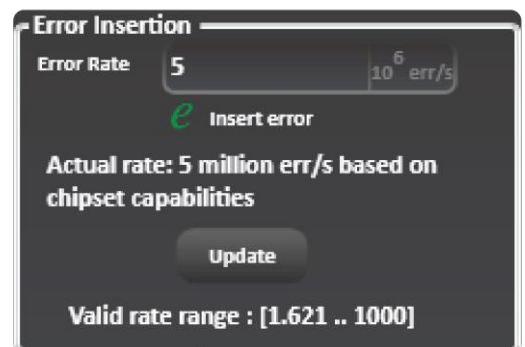

Figure 18: Error insertion in optimal mode

TX Control in Advanced Mode

While operating in Advanced Mode, you can fine-tune the transmitter signal with high granularity. You will be able to specify the following TX settings and parameters:

- **TX Pattern:** Supported TX patterns are all available in the dropdown list, depending on the BERT model in use.
- **FFE Taps:** Tap control offers the following on TX:
 - Scaling between 60% and 120%
 - 3 FFE taps (in 3-tap mode) and FIR filter 7 taps (in 7-tap mode). Supported tap values range between -1000 and 1000.
 - Inner and Outer Eye: Controls only available in PAM4 mode (Inner eye value is between 500 and 1500, while Outer eye is in between 1500 and 2500).

To start optimizing the TX setting, follow these steps:

- **Enable the TX settings control** of the channel (TX button ON/OFF).
- **Select a TX pattern.**
- **Customize the FFE taps.** Scaling, FFE taps, and Inner and Outer Eye can be controlled in this tab.
- **Apply the changes** by clicking on the “Set” button.

You can load/save FFE Taps file to load and use a previous FFE configuration or save it for later use by clicking on the  buttons in the corner.

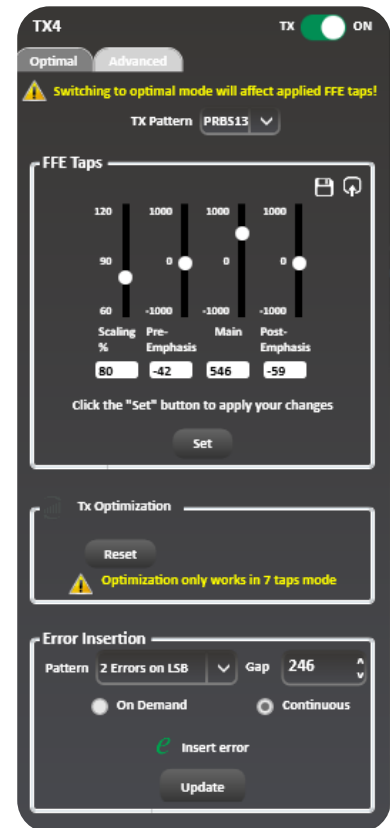



Figure 19: TX advanced mode control

■ Error Insertion

You can insert errors in a continuous mode or on-demand. By default, the on-demand feature is enabled.

When inserting errors on-demand:

- **Enable Error Insertion mode.**  
- **Select the pattern.** Patterns depend on the modulation type (Figures 20 and 21).
- **Set the gap.** The sequence of words to skip without error insertion (0 ... 225 words).
- **Set the Duration.** The number of repetitions in which the selected number of errors will be injected.
- **Click on insert.**

To insert errors in continuous mode:





- **Disable Error insertion.**  
- **Select Continuous Mode.**
- **Enable Error insertion.**  



Figure 20: Error injection tab

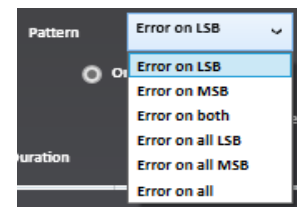

Figure 21: Error patterns in PAM4

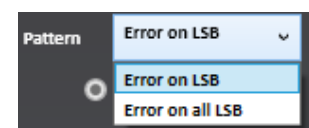

Figure 22: Error patterns in NRZ

NOTES:

Optimal configurations and calibration are only available in 3-tap mode. The Channel Emulation feature is only supported in 7-tap mode.

- Channel emulation.** To emulate channel loss, start by clicking the emulation button. When enabled, the emulation button will turn to green.  You can insert the magnitude of the loss at the Nyquist frequency (half of the configured baud rate) in decibels. In addition, an S-parameter file can be selected, loaded, and used to calculate the taps creating the entered loss value.



Figure 23: Channel emulation enabled

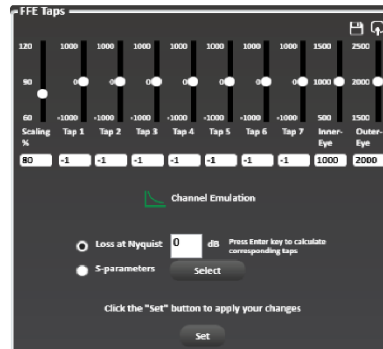

Figure 24: 7-tap FIR filter with channel emulation enabled

TX Auto-Optimization mode

This feature is still undergoing testing. Functionality is available in limited used cases as of version 2.4.

Operate in 7-tap mode to enable TX auto-optimization mode. After enabling 7-tap mode, you can now apply the auto-optimization settings where the ThunderBERT GUI will calculate the optimized FFE taps for the current setup.

To **apply** the TX Optimization settings:

- Enable TX Optimization** by clicking on the button right next to the Tab. When enabled, the button turns green.
- Click on the Optimization button** to calculate the optimal FFE Taps for the testing setup.

You can reset the **FFE Taps values** anytime by clicking on the **Reset button**.

To perform the Optimization process on the current setting, a lock must be detected on the channel in question.

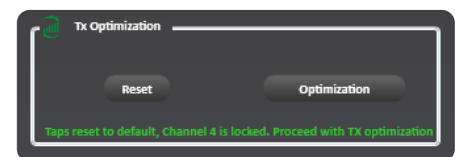
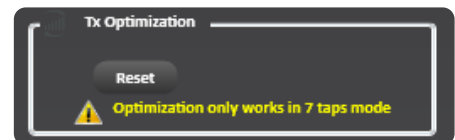

Apply to all channels option

This option is used for the TX and RX settings, and transceiver control if available. When selected, it applies the configuration of the current channel to all BERT channels. For example, pressing “Apply to all” on the TX window will apply all TX configurations displayed in this window to every other channel.

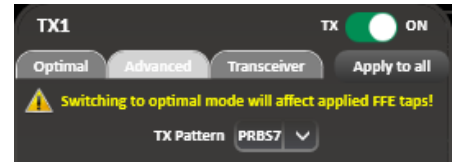

RX Control

RX settings can also be controlled on a per-channel basis. A window reflecting all the enabled features and applied receiver settings per channel is displayed after clicking on each RX channel tab. You will be able to select/configure the following settings:

- **RX Pattern** (supported RX patterns depend on the BERT in use).
- **RX Invert**: Inverts the RX polarity. The button becomes green indicating that RX polarity is inverted.
- **Equalization type**: Includes DFE, RC, LDEQ, and MPICAN (supported EQ types appear in this block according to the BERT type).
 - **DFE** (Decision Feedback Equalizer) is used for strenuous links.
 - **RC** (Reflection Canceller) extends the FFE and smooths out the tail in the pulse response. It is used for links with strong reflections or that have too high energy in the pulse response tail.
 - **LDEQ** (Level-Dependent Equalizer) equalizes the signal differently for each voltage level. It is used for optics which may have non-uniform eye openings at each voltage level.
 - **MPICAN** (Multipath Interference Canceller).
- **RX Diagnostics** ^{RX-AV}: This Window monitors FFE Taps, SNR and Histogram graphs over time.
- **RX Pattern Lock**: The button is usually red, but turns green when the pattern is locked and identified successfully.



Figure 25: RX channel display

Figure 26: RX side control tab

The RX channel tab employs green shading to highlight the enabled RX features (*RX polarity inversion, RC, LDEQ, MPICAN*).



Figure 27: RX side with different EQ types enabled

Rx Diagnostics

To access the RX diagnostics graph section, select the RX button found in the RX configuration window of each channel.

After pressing the button, RX diagnostics button is shaded in green and a graph section will appear as shown in Figure 27.

The Rx diagnostics features 3 measurement tabs:

- **FFE Taps:** Displays the Feed Forward Equalizer tap values.
- **SNR:** Measures Signal to Noise Ratio in decibels (dB).
- **Histogram:** Measures density distribution of the samples.



Figure 28: Enabling RX diagnostics

Screenshots of the available RX diagnostics measurements graphs are shown in Figures 29-31.

RX Diagnostics graphs

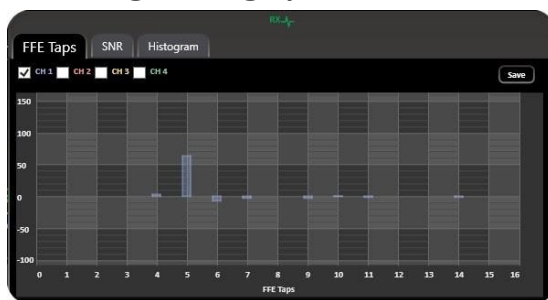

Figure 29: Rx diagnostics FFE Taps

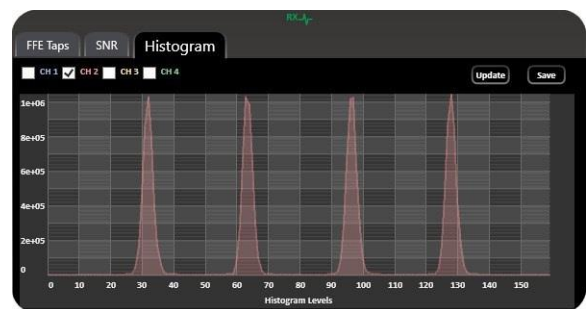

Figure 30: Rx diagnostics histogram

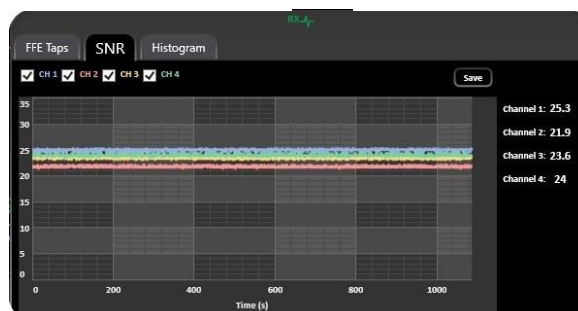

Figure 31: Rx diagnostics SNR with all channels

NOTES:

- You can save the graphs with the save button in the upper righthand corner of the window.
- You also have the option to view all the channels at once for selected measurements (Figure 31).

Clock Configuration

With ThunderBERT, you can choose between different clock configuration options:

- **Internal Clock Mode or RefClk:** Choose between reference or monitor clock generators (rates dividers depend on the type of BERT in use, check specific BERT datasheets for more details).
- **External Clock Rate or Clk-In:** Clock-in support varies depending on HW revision and should respect the supported clock rate in limits. When the Clk-In mode is enabled, you cannot use the BERT as a reference clock generator (Clk-Out). The permissible analog clock input range for the ML BERT platforms varies between 136.36 and 178.78 MHz with an optimal value of 156.25 MHz. Optimal frequency will be visible within the Clk-In menu of ThunderBERT.

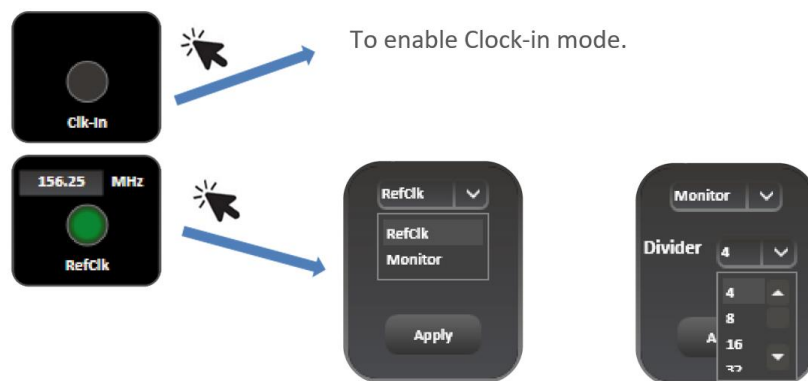

Figure 32: Clock options

Jitter Injection

All BERT platforms supported via ThunderBERT can accept an external input clock which will enable sinusoidal and random jitter injection for jitter tolerance (JTOL) testing for DUTs. First, set the clock mode to be Clk-In mode per the previous section. MultiLane offers the ML407-PAM as a jittered clock source, more information on this solution can be found on the [MultiLane website](https://www.multilane.com).









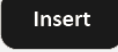
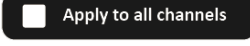
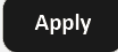

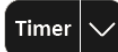

Figure 33: Jitter tolerance hardware setup

Supported Measurements

The ThunderBERT platform provides comprehensive control of all supported measurements including BER, FEC, SER, and RX diagnostics.

Measurement Controls

Table 1: Measurement Controls

Control	Definition
	Start and Stop BER, FEC, and SER measurements
	RX diagnostics: RX FFE taps, SNR, and Histogram Control
	Capture histogram and update error insertion rate
	Save RX FFE taps, SNR values, histogram captures
	Save and Load FFE taps, Save and Load BERT settings
	Set FFE taps
	Insert Errors
	Apply unified settings on all channels (supported on both TX and RX sides)
	Apply bit rate, clock rates, FEC, and 3- and 7-tap mode
	Graph Autoscale
	TX ON/OFF AND Enable/ Disable History navigation measurements to be listed in details tab
	BER/ FEC Measurement Timer
	Additional Options

Generic Measurements

You can execute BER measurements according to the channels you select. While the test is running, you can change the X and Y axis according to the supported graph combinations. You have the choice to measure/visualize different options such as:

- *Single and Multichannel BER*
- *Accumulated and Instant BER*
- *Continuous BER Test*
- *Time-defined BER Test*

Supported measurements are grouped in the following table:

Table 2: Supported BER Measurements

Instant Measurements	Accumulated Measurements
Instant BER	Real Time BER
Instant Error Count	Accumulate Error Count
Instant BER MSB	Real Time BER MSB
Instant BER LSB	Real Time LSB
Instant Error Count MSB	Accumulated Count MSB
Instant Error Count LSB	Accumulated Error Count LSB

To start visualizing the selected BER results/measured data, select the channel(s) on which the measurement(s) are to be displayed and press the Start button to run the measurement. There is also an option to select/deselect all channels.

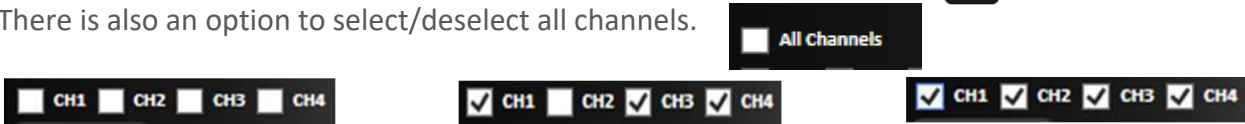

Figure 34: Clock options

Instant and accumulated measurements can be displayed simultaneously in the details panel and on the graph. In addition, you can navigate through the measurement behavior at any past time in the test using **History Navigation** in the details panel at 100 ms intervals.

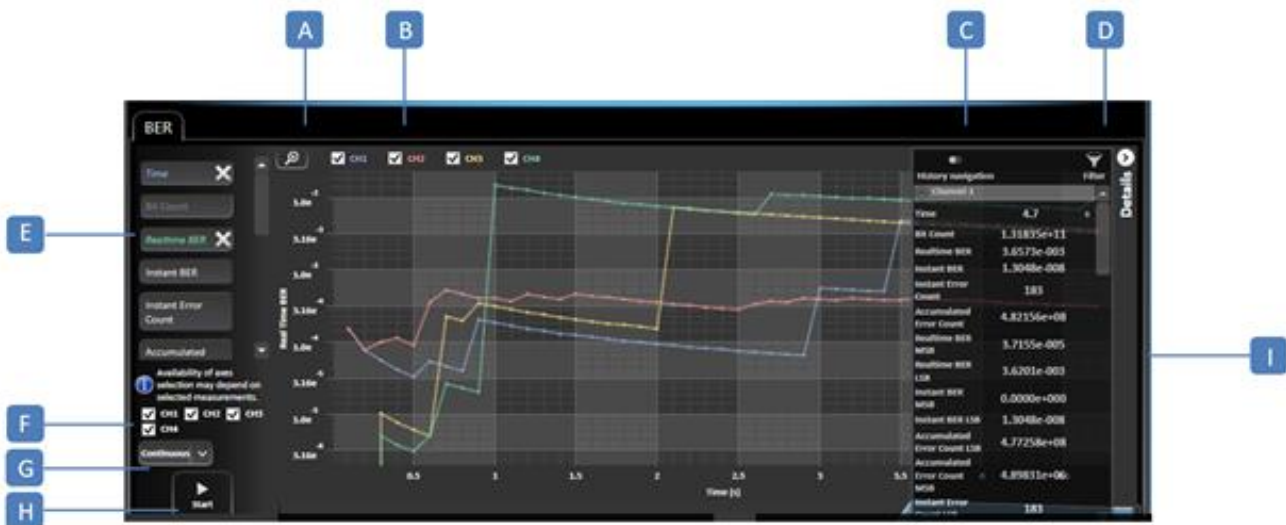

Figure 35: Measurement display

- A: Graph Autoscale – B: Channel Selection – C: History Navigation – D: Measurement Filtering –
- E: Graph Display Measurements Selection (axes) – F: Channel Selection – G: Timer/Continuous Mode –
- H: Stop/Start BER – I: Details panel

! X-axis selection: To enable measurements, select a value for both the X and Y axis. Different options for the X axis selection are supported, but only one can be selected per measurement, while more than one Y axis can be selected and displayed simultaneously. The scale of each Y axis selected will be displayed on the left of the graph.

A display of supported NRZ/PAM4 BER graph combinations is shown below depending on the measurement type:

- *PAM 4 Measurements*

Table 3: PAM4 BER Graph Combinations

X axis	Y axis
Time	Real Time BER
	Instant BER
	Instant Error Count
	Accumulated Error Count
	Real Time BER MSB
	Real Time BER LSB
	Instant BER MSB
	Instant BER LSB
	Accumulated Error Count MSB
	Accumulated Error Count LSB
	Instant Error Count MSB
	Instant Error Count LSB

X axis	Y axis
Bit Count	Real Time BER
	Instant BER
	Instant Error Count
	Accumulated Error Count
	Real Time BER MSB
	Real Time BER LSB
	Instant BER MSB
	Instant BER LSB
	Accumulated Error Count MSB
	Accumulated Error Count LSB
	Instant Error Count MSB
	Instant Error Count LSB

X axis	Y axis
Accumulated Error Count	Instant BER
	Instant Error Count
	Instant BER MSB
	Instant BER LSB
	Accumulated Error Count MSB
	Accumulated Error Count LSB
	Instant Error Count MSB
	Instant Error Count LSB

X axis	Y axis
Accumulated Error Count LSB	Instant BER LSB
	Instant Error Count LSB

X axis	Y axis
Accumulated Error Count MSB	Instant BER MSB
	Instant Error Count MSB

- *NRZ measurements*

Table 4: NRZ BER Graph Combinations

X axis	Y axis
Time	Real Time BER
	Instant BER
	Instant Error Count
	Accumulated Error Count

X axis	Y axis
Bit Count	Real Time BER
	Instant BER
	Instant Error Count
	Accumulated Error Count

X axis	Y axis
Accumulated Error Count	Instant BER
	Instant Error Count

After selecting the desired graph configuration, data will be plotted instantly (make sure to choose the desired channel and click on the Start button).

You can access the instant and accumulated measurements data using the BER measurements table. You can switch from graph to table measurements with no test interruptions. You can save the table of result onto your desktop using the save button.

BER graphs and table measurements are displayed below in Figures 36 -1 and 36-2.



Figure 36-1: Error tracking vs. time



Figure 36-2: BER table measurements

Platform Specific Measurements

MultiLane offers both emulated and real hardware FEC-supporting devices. Available FEC measurements depend on the HW revisions and the type of BERT in use. In this section, the supported specific measurements will be detailed.

Activating a purchased Real Hardware FEC License

To Enable FEC licensing, you can request FEC License by placing a Purchase Order to operation@multilaneinc.com by sending a screenshot of your BERT info tab.

After purchasing real hardware FEC license, you will be eligible for a license key (LK). This LK is needed to unlock all real hardware FEC features.

After clicking on “Add License” available in Info tab, a pop-up window will appear, where your LK should be copied and applied.



Figure 37: Add license available in Info tab

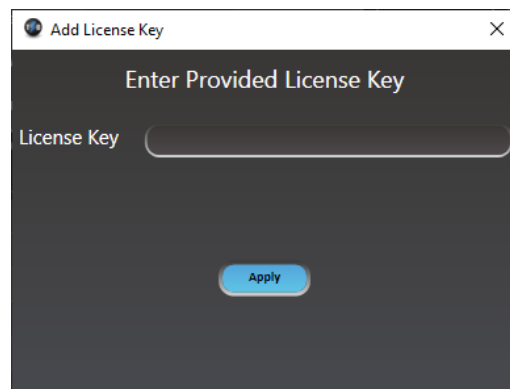

Figure 38: Pop-up window to add license

If the LK is valid, another pop-up window will appear, informing you that the LK has been applied.

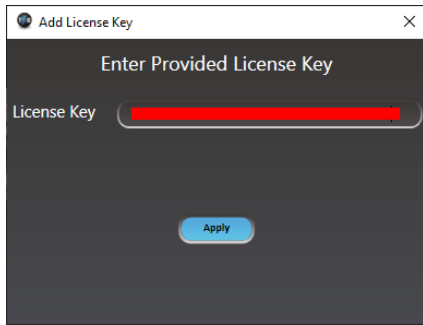

Figure 39: License key added

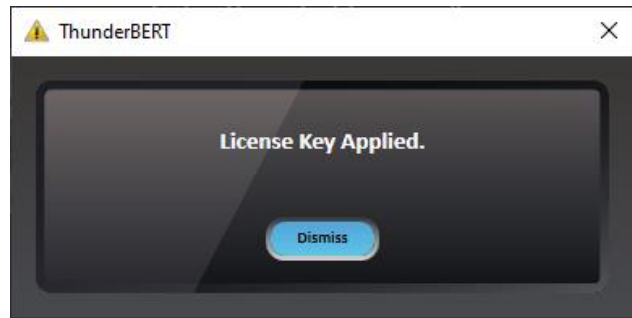

Figure 40: FEC features enabled

After you have applied your LK, the BERT *should be disconnected* and *power cycled*. Full hardware FEC features will then be accessible and ready to use.



You will be notified if a wrong LK is entered (figure 41). The GUI will disconnect directly if a wrong LK is entered four times consecutively (figure 42).

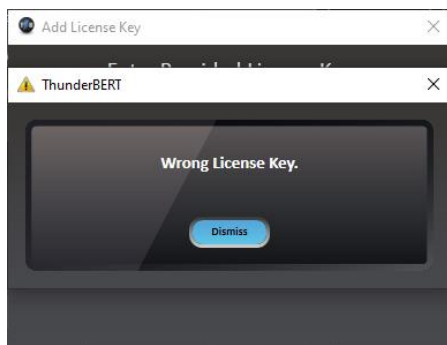

Figure 41: Wrong license key

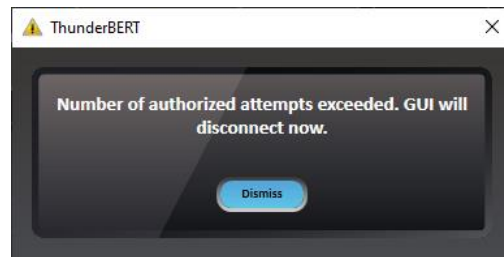

Figure 42: Number of authorized attempts exceeded

Real Hardware FEC Measurements

Supported on ML4039B, ML4054B, ML4039E(N), and ML4079E(N) only.

After entering an applicable FEC license code into ThunderBERT, enable the FEC measurements from the drop-down list and then press apply. Once enabled, the FEC button will become green and display the FEC type selected.

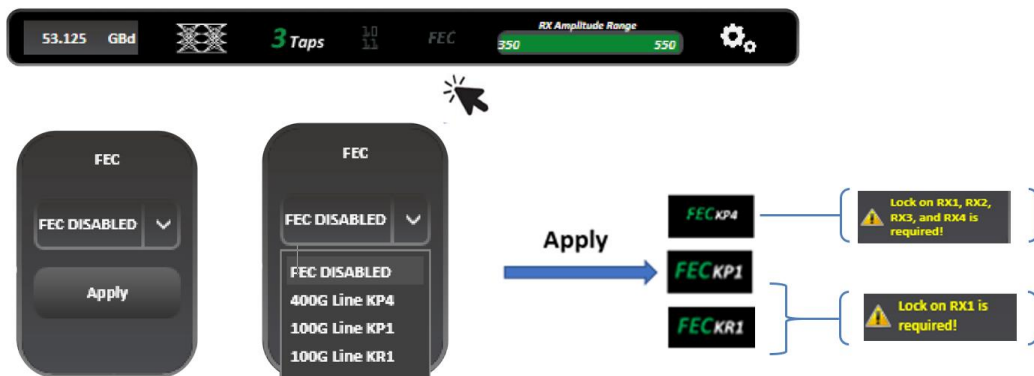

Figure 43: Enabling FEC

When FEC is enabled, you can change the X and Y axes to the supported graph combinations where instant and accumulated bit counts are supported and can see the results of the measurements in the details section. SER measurements are also supported in FEC mode; corrected codewords with symbol error distribution are displayed.

Table 5: Instant and Accumulated Real Hardware FEC Measurements

Instant and Accumulated Measurement	Measurement Description
Corrected Bit Count	Sum of corrected “0” and “1” bits after decoding.
Corrected Zero Count	Number of “0” bits that were corrected to be “1” bits after decoding.
Corrected One Count	Number of “1” bits that were corrected to be “0” bits after decoding.
Processed Codeword Count	Total number of codewords, correctable and uncorrectable processed by the decoder.
Corrected Codeword Count	Number of codewords (FEC blocks) that were corrected by the decoder, which means the number of codewords that were determined to have a correctible magnitude of symbol errors.
Uncorrected Codeword Count	Total number of codewords that were deemed uncorrectable by the decoder, which means number of codewords that were determined to have more than the correctible magnitude of symbol errors.
Uncorrected Codeword Rate	Number of uncorrected codewords compared to the number of processed codewords.
FEC Symbol Error Rate	Number of symbol errors divided by the total number of processed symbols.
FEC Symbol Error Count	Total number of symbol errors processed by the decoder.
Pre-FEC BER	Raw and unframed ratio of incorrect bits (Bit Errors/Total Bits) on a channel-by-channel basis.
Post-FEC BER	Total number of bit errors remaining after real FEC decoding divided by the total number of received bits.

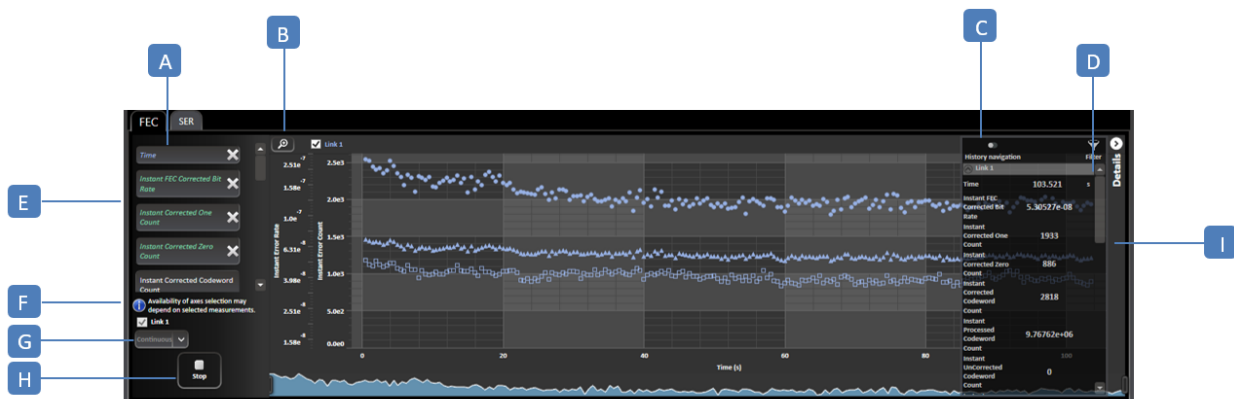



Figure 44: Measurement display

- A: FEC/SER graphs – B: Graph Auto Scale – C: History Navigation – D: Measurement Filtering
- E: Graph Display Measurements Selection – F: Link Selection – G: Timer/Continuous Mode
- H: Stop/Start FEC/SER – I: Details panel



To enable measurements, select a value for both the X and Y axes*. Different options for the X axis selection are supported, but only one can be selected per measurement, while more than one Y axis can be selected and displayed simultaneously. The scale of each Y axis selected will be displayed on the left of the graph.

You can choose between visualizing instant and accumulated measurements, and measurements table under the FEC and SER tabs. You can save the table of result on your desktop using the save  button. Some FEC and SER screenshots are shown below:

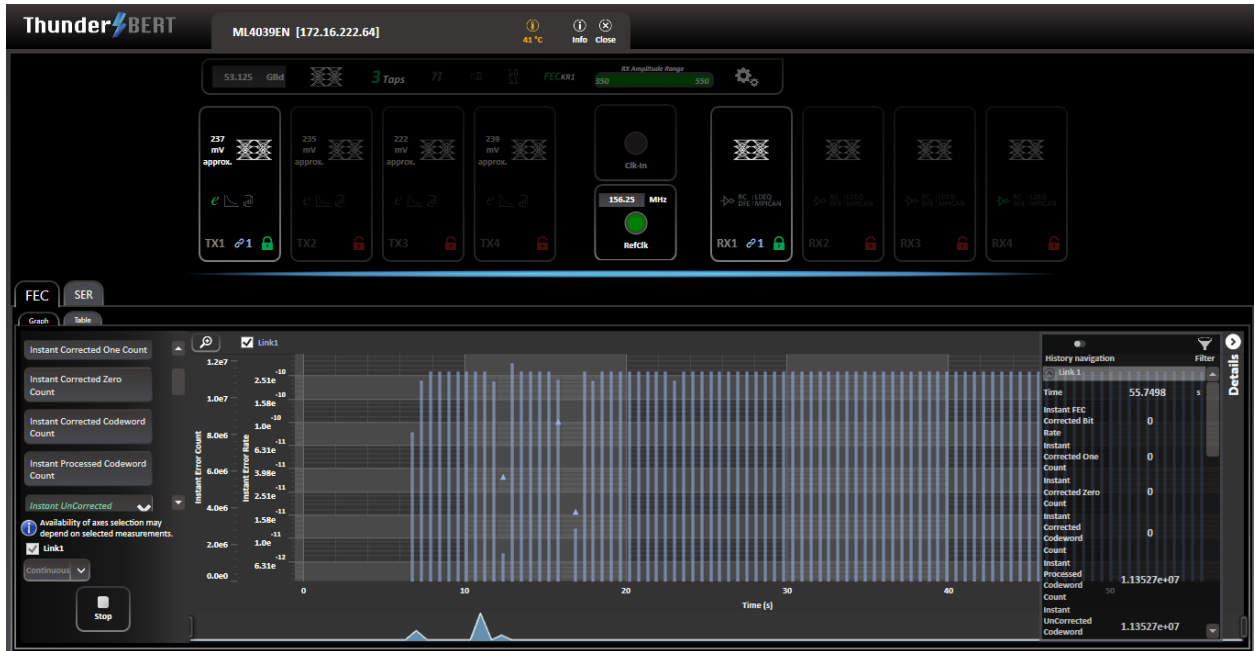

Figure 45: FEC graph with details panel

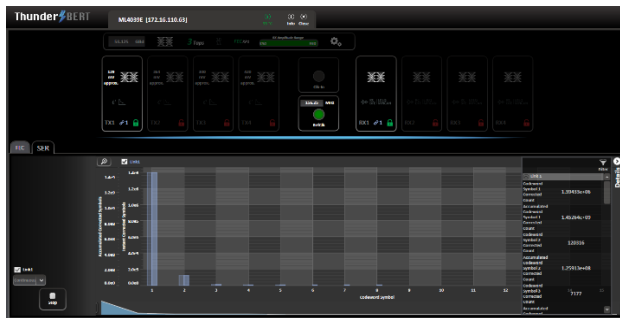

Figure 46: SER graph

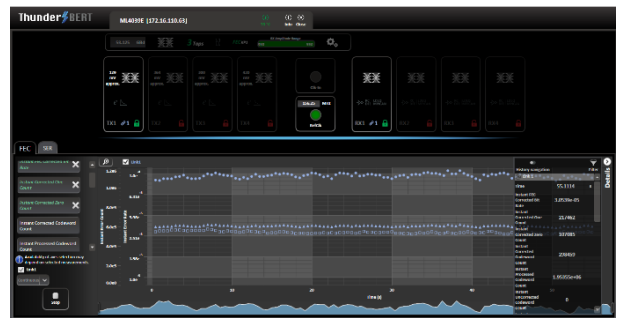

Figure 47: Instant FEC measurements graph

	Link 1	Link 2	Link 3	Link 4	Link 5	Link 6	Link 7	Link 8
Instant Corrected One Count	4.9100e+07	5.1100e+07	5.1100e+07	5.1100e+07	5.1100e+07	5.1100e+07	5.1100e+07	5.1100e+07
Instant Corrected Zero Count	0	0	0	0	0	0	0	0
Instant Processed Codeword Count	1.0127e+08	1.0127e+08	1.0127e+08	1.0127e+08	1.0127e+08	1.0127e+08	1.0127e+08	1.0127e+08
Instant UnCorrected Count	0	0	0	0	0	0	0	0
Instant Corrected One Count	0	0	0	0	0	0	0	0
Instant Corrected Zero Count	0	0	0	0	0	0	0	0
Instant Processed Codeword Count	2.4652e+07	2.4652e+07	2.4652e+07	2.4652e+07	2.4652e+07	2.4652e+07	2.4652e+07	2.4652e+07
Instant UnCorrected Count	0	0	0	0	0	0	0	0
Instant Corrected One Count	0	0	0	0	0	0	0	0
Instant Corrected Zero Count	0	0	0	0	0	0	0	0
Instant Processed Codeword Count	0	0	0	0	0	0	0	0
Instant UnCorrected Count	0	0	0	0	0	0	0	0

Figure 48: FEC Table

	Link 1	Link 2	Link 3	Link 4
Time (s)	0.000000	0.000000	0.000000	0.000000
Symboled 0	0.000000	0.000000	0.000000	0.000000
Symboled 1	0.000000	0.000000	0.000000	0.000000
Symboled 2	0.000000	0.000000	0.000000	0.000000
Symboled 3	0.000000	0.000000	0.000000	0.000000
Symboled 4	0.000000	0.000000	0.000000	0.000000
Symboled 5	0.000000	0.000000	0.000000	0.000000
Symboled 6	0.000000	0.000000	0.000000	0.000000
Symboled 7	0.000000	0.000000	0.000000	0.000000
Symboled 8	0.000000	0.000000	0.000000	0.000000
Symboled 9	0.000000	0.000000	0.000000	0.000000
Symboled 10	0.000000	0.000000	0.000000	0.000000
Symboled 11	0.000000	0.000000	0.000000	0.000000
Symboled 12	0.000000	0.000000	0.000000	0.000000
Symboled 13	0.000000	0.000000	0.000000	0.000000
Symboled 14	0.000000	0.000000	0.000000	0.000000
Symboled 15	0.000000	0.000000	0.000000	0.000000
Symboled over 15	0.000000	0.000000	0.000000	0.000000
SER (Mean)	0.000000	0.000000	0.000000	0.000000
Power-FEC FER	0.000000	0.000000	0.000000	0.000000
FEC Lines	0.000000	0.000000	0.000000	0.000000

Figure 49: SER Table

*To view the axes combination measurements, refer to the combination tables on page 27-28

There are three measurement blocks for SER:

1. Instant Codeword Symbol: the symbol error rate distribution for the link under test in a specific 100 ms window. Refreshes 10 times per second.
2. Accumulated Codeword Symbol: the sum of total symbol error rate distribution for the link under test, accumulating from t =0.
3. Accumulated Percentage Distribution: the percentage distribution of total symbol error rate for the link under test, accumulating from t=0.
4. The measurements will display:
 - a. Symbols ranging from 0 to 7 or from 0 to 15 (depending on the mode).
 - b. Symbols greater than 7 or 15 (depending on the mode).
 - c. The SER margin (metric indicating available margin before codewords become uncorrectable).
 - d. The post-FEC FER (Frame Error Rate).
 - e. The FEC link.

In the following tables, the supported Real Hardware FEC graph combinations are shown.

Table 6: Display of additional FEC combinations

X axis	Y axis
Time	Instant FEC corrected Bit Rate
	Instant Corrected One Count
	Instant Corrected Zero Count
	Instant Corrected Codeword Count
	Instant Processed Codeword Count
	Instant Uncorrected Codeword Count
	Instant Uncorrected Codeword Error Rate
	Instant Corrected Bit Count
	Instant Frame Error Rate
	Instant FEC Symbol Error Count
	Instant FEC Symbol Error Rate
	Accumulated Corrected Ones Count
	Accumulated Corrected Zeros Count
	Accumulated Corrected Codeword Count
	Accumulated Processed Codeword Count
	Accumulated Uncorrected Codeword Count
	Accumulated Corrected Bit Count
	Accumulated FEC Symbol Error Count
	Accumulated FEC Corrected Bit Rate
	Averaged Uncorrected Codeword Rate
Averaged FEC Symbol Error Rate	

X axis	Y axis
Accumulated Processed Codeword Count	Instant FEC corrected Bit Rate
	Instant Corrected One Count
	Instant Corrected Zero Count
	Instant Corrected Codeword Count
	Instant Processed Codeword Count
	Instant Uncorrected Codeword Count
	Instant Uncorrected Codeword Error Rate
	Instant Corrected Bit Count
	Instant Frame Error Rate
	Instant FEC Symbol Error Count
	Instant FEC Symbol Error Rate
	Accumulated Corrected Ones Count
	Accumulated Corrected Zeros Count
	Accumulated Corrected Codeword Count
	Accumulated Uncorrected Codeword Count
	Accumulated Corrected Bit Count
	Accumulated FEC Symbol Error Count
	Averaged FEC Corrected Bit Rate
	Average Uncorrected Codeword Rate
	Averaged FEC Symbol Error Rate

X axis	Y axis
Accumulated Corrected Zeros Count	Instant FEC corrected Bit Rate
	Instant Corrected One Count
	Instant Corrected Zero Count
	Instant Corrected Codeword Count
	Instant Uncorrected Codeword Count
	Instant Uncorrected Codeword Error Rate
	Instant Corrected Bit Count
	Instant Frame Error Rate
	Instant FEC Symbol Error Count
	Instant FEC Symbol Error Rate
	Accumulated Corrected Ones Count
	Accumulated Corrected Codeword Count
	Accumulated Uncorrected Codeword Count
	Accumulated Corrected Bit Count
	Accumulated FEC Symbol Error Count

X axis	Y axis
Accumulated Corrected Ones Count	Instant FEC corrected Bit Rate
	Instant Corrected One Count
	Instant Corrected Zero Count
	Instant Corrected Codeword Count
	Instant Uncorrected Codeword Count
	Instant Uncorrected Codeword Error Rate
	Instant Corrected Bit Count
	Instant Frame Error Rate
	Instant FEC Symbol Error Count
	Instant FEC Symbol Error Rate
	Accumulated Corrected Zeros Count
	Accumulated Corrected Codeword Count
	Accumulated Uncorrected Codeword Count
	Accumulated Corrected Bit Count
	Accumulated FEC Symbol Error Count

X axis	Y axis
Accumulated Corrected Codeword Count	Instant FEC corrected Bit Rate
	Instant Corrected One Count
	Instant Corrected Zero Count
	Instant Corrected Codeword Count
	Instant Uncorrected Codeword Count
	Instant Uncorrected Codeword Error Rate
	Instant Corrected Bit Count
	Instant Frame Error Rate
	Instant FEC Symbol Error Count
	Instant FEC Symbol Error Rate
	Accumulated Corrected Ones Count
	Accumulated Corrected Zeros Count
	Accumulated Corrected Codeword Count
	Accumulated Uncorrected Codeword Count
	Accumulated Corrected Bit Count
Accumulated FEC Symbol Error Count	

X axis	Y axis
Accumulated Uncorrected Codeword Count	Instant FEC corrected Bit Rate
	Instant Corrected One Count
	Instant Corrected Zero Count
	Instant Corrected Codeword Count
	Instant Uncorrected Codeword Count
	Instant Uncorrected Codeword Error Rate
	Instant Corrected Bit Count
	Instant Frame Error Rate
	Instant FEC Symbol Error Count
	Instant FEC Symbol Error Rate
	Accumulated Corrected Ones Count
	Accumulated Corrected Zeros Count
	Accumulated Corrected Codeword Count
	Accumulated Uncorrected Codeword Count
	Accumulated Corrected Bit Count
Accumulated FEC Symbol Error Count	

X axis	Y axis
Accumulated FEC Symbol Error Count	Instant FEC corrected Bit Rate
	Instant Corrected One Count
	Instant Corrected Zero Count
	Instant Corrected Codeword Count
	Instant Processed Codeword Count
	Instant Uncorrected Codeword Count
	Instant Uncorrected Codeword Error Rate
	Instant Corrected Bit Count
	Instant Frame Error Rate
	Instant FEC Symbol Error Count
	Instant FEC Symbol Error Rate
	Accumulated Corrected Ones Count
	Accumulated Corrected Zeros Count
	Accumulated Corrected Codeword Count
	Accumulated Uncorrected Codeword Count
	Accumulated Corrected Bit Count

X axis	Y axis
Accumulated Corrected Bit Count	Instant FEC corrected Bit Rate
	Instant Corrected One Count
	Instant Corrected Zero Count
	Instant Corrected Codeword Count
	Instant Processed Codeword Count
	Instant Uncorrected Codeword Count
	Instant Uncorrected Codeword Error Rate
	Instant Corrected Bit Count
	Instant Frame Error Rate
	Instant FEC Symbol Error Count
	Instant FEC Symbol Error Rate
	Accumulated Corrected Ones Count
	Accumulated Corrected Zeros Count
	Accumulated Corrected Codeword Count
	Accumulated Uncorrected Codeword Count
	Accumulated FEC Symbol Error Count

Emulated FEC measurements

Supported on the ML4039D and ML4079D.

Emulated FEC does not require a license and is a standard feature supported in the ML4039D and ML4079D ThunderBERT platforms. You can enable Emulated FEC measurements from the drop-down list and then press apply. Once enabled, the FEC button will become green and display the FEC type selected.



Figure 50: Enabling the Emulated FEC Measurements

Table 7: Instant and Accumulated Emulated FEC Measurements

Instant and Accumulated Measurement Selection	Measurement Description
Pre-FEC Bit Error Rate	Raw and unframed ratio of incorrect bits (Bit Errors/Total Bits) on a channel-by-channel basis.
Post-FEC Bit Error Rate	Total number of bit errors remaining after emulated bit correction divided by the total number of received bits.
Corrected Errors	Number of correctable bits determined by the error distribution algorithm in the FEC emulator.
Block Count	Total number of bit stream blocks (emulated codewords) processed by the emulation algorithm.
Error Count	Total number of PRBS errors captured by the error detector for a specific test duration.
Saturated Block Count	Total number of emulated codewords that were determined to be uncorrectable based on the distribution algorithm implemented by the FEC emulator.
Symbol Error Rate Histogram	Calculated distribution of bit stream blocks sorted by numbers of symbol errors per emulated block.

In the following tables, the supported Emulated FEC graph combinations are shown. Please note that the SER measurement features covered in the Real FEC section are also supported on Emulated FEC platforms.

Table 8: Emulated FEC axes Combinations

X axis	Y axis
Time	Instant Corrected Bit Error Count
	Instant Processed Codeword Count
	Instant Saturated FEC Blocks
	Accumulated Corrected Bit Error Count
	Accumulated Processed Codeword Count
	Accumulated Saturated FEC Blocks

X axis	Y axis
Accumulated Processed Codeword Count	Instant corrected Bit Error Count
	Instant Processed Codewords Count
	Instant Saturated FEC Blocks
	Accumulated Corrected Error Count
	Accumulated Saturated FEC Blocks

Noise Injection and Shallow Loopback Measurements

Supported on the ML4039EN and ML4079EN.

With the ML4039EN and ML4079EN, you can realize noise injection to emulate real-life crosstalk scenarios along with shallow loopback testing.

Noise implementation can be implemented in the form of a continuous interference, burst crosstalk, or single shot noise.

In the following pictures, before and after noise injection on the PAM4 eye diagram is depicted.

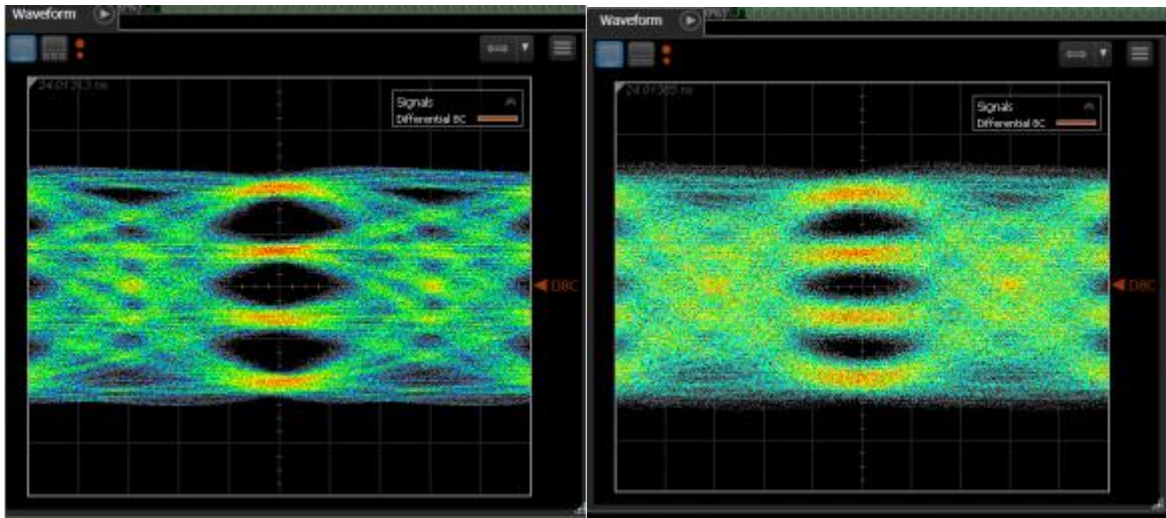

Figure 51: PAM4 eye diagram with and without noise injection applied

Noise settings can be configured on each channel independently.

To enable Noise Injection:

- **Enable** noise insertion mode via the *n* button in the top configuration bar.
- **Select** the desired type of Noise Injection. *Currently supported options are Random and Burst Noise.*
- **Configure** noise injection value in digital scale (0-1000).
- **Apply** changes (on each channel independently).

NOTES:

To enable Shallow Loopback:

- **Enable** function via the C_{RX}^{TX} button in the top configuration bar.
- **Connect** an external traffic source to the RX port(s) of the BERT. *External traffic must be within the following range: 23-29 or 46-56 GBd.*
- **Inject** noise into the external traffic via the Noise Injection menu on each channel.
- **Apply** intended noise injection on the looped-back external signal.
- **Access** looped-back traffic via the TX ports.

NOTES:

The shallow loopback function works with a variety of traffic types including unframed PRBS, framed ethernet and FEC traffic. The following figure depicts a ML4039EN accepting traffic from an external 400G switch, looping the traffic back internally and re-transmitting it back to the RX side of the host.

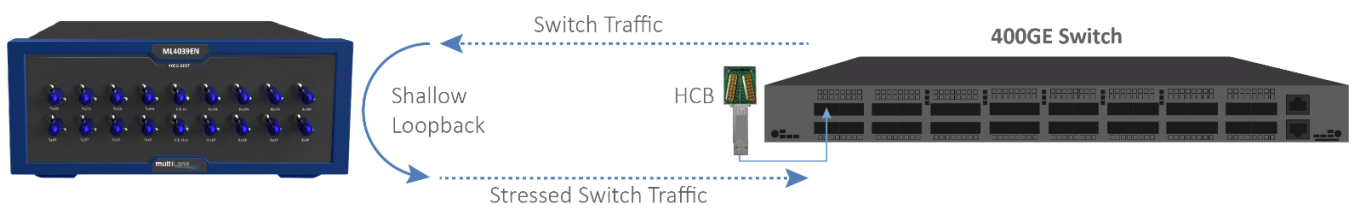

Figure 52: Shallow loopback setup using ML4039EN and 400G switch

Host Interface for Module Management

Supported on the ML4054B.

Module Management Interface

The ML4054B features an embedded module adapter which integrates module management features into the ThunderBERT GUI itself.

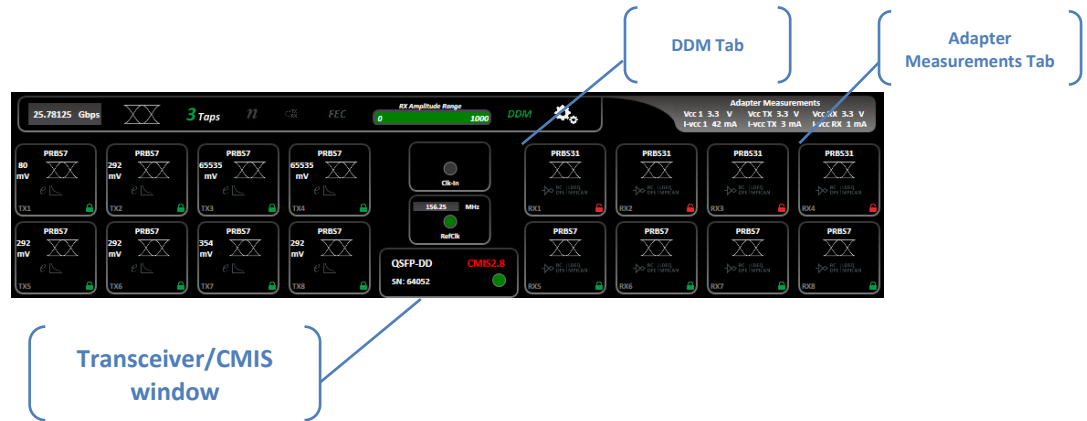

Figure 53: Module management tabs using ThunderBERT GUI

DDM Tab

The DDM tab (Digital Diagnostic Monitoring) depicts the diagnostic readout of the populated transceiver in real time. These key parameters include module temperature, V_{CC} supply voltage, TX bias current, TX-side average output power, and RX-side average input power.



Figure 54: Digital Diagnostic Monitoring tab (DDM)

You can read the populated values in AUX 1, AUX2, and AUX3 according to the vendor implementation. The following values can be displayed according to CMIS compliance:

Table 9: Optional Auxiliary Readings (CMIS)

Aux	Flag
Aux1	TEC Current
Aux2	TEC Temperature
Aux2	Laser Temperature
Aux2	Laser Temperature
Aux3	Aux voltage

Alarms

The DDM button itself reflects the state of the module to monitor. The button changes its color according to the state of parameters:

- **DDM** indicates all the values are in normal range of operation.
- **DDM** indicates that at least one warning is issued.
- **DDM** indicates that at least one alarm is issued.

To illustrate the DDM button variation, the three states are illustrated by an alarm notification as shown in the following figures:

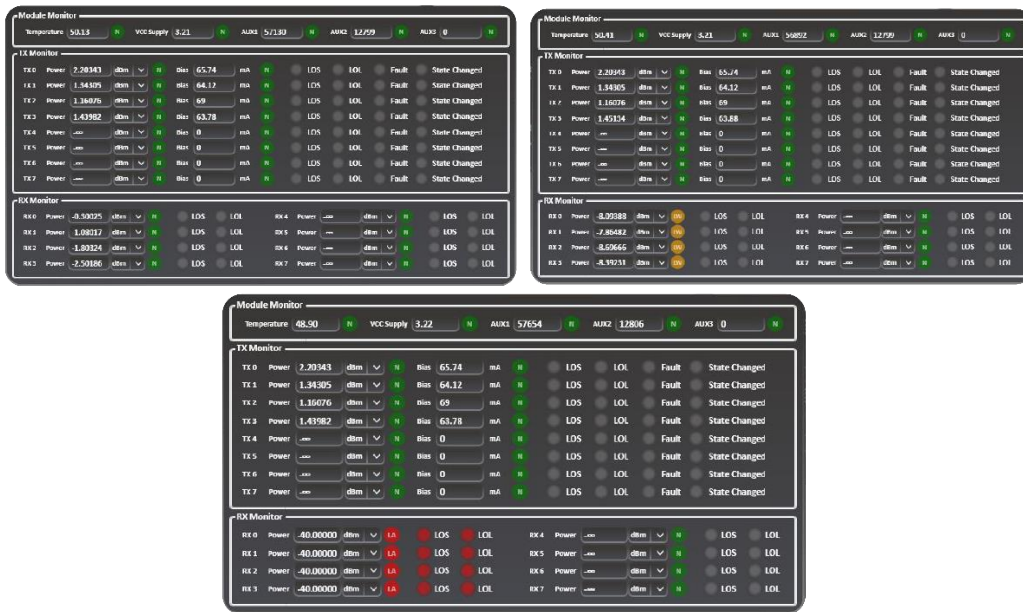

Figure 55: DDM Tab with normal, warning and alarm conditions

NOTES:

- The “Normal”, “Warning” and “Alarm” thresholds for each DDM parameter are pulled from the populated modules’ memory map as per CMIS requirements.

Transceiver / CMIS window

The transceiver window provides you with general information about the used adapter as follows:

- Type of the adapter in use (QSFP-DD, OSFP, QSFP28, etc.)
- Serial Number of the populated module
- CMIS version of the populated modules
- Connection status LED indicator

- A
- B
- C
- D



NOTES:

- The populated module should be CMIS3.0 or CMIS4.0 compliant in order to leverage the Transceiver menu (TB v1.5.0). In case of a lack of CMIS compliance, the CMIS button turns red and the displayed measurements might be erroneous due to module register mismatch.

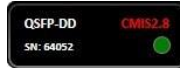

- The connection LED indicates whether or not the module is connected to the adapter. It turns red when there is no connection detected.

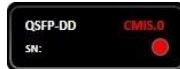

- **Identification Tab** indicates the vendor details, specifications, and cable length properties of the populated module.
- After changing the module, you can refresh the information by clicking on the Refresh button.

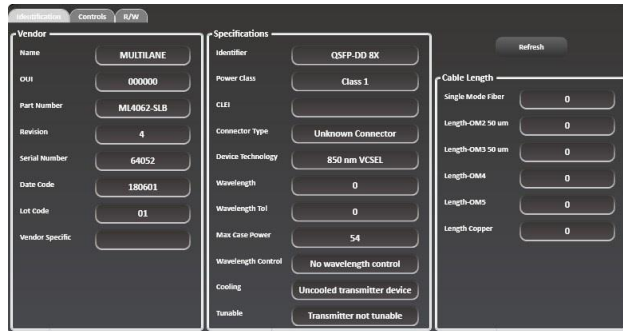

Figure 56: Identification tab of the CMIS window

- **Controls Tab** gives you access to control the module configurations:
 - **LPMODE:** when activated, the module is in low power mode. All power dissipation is stopped, and the LED color will change to orange. In high power mode (LPMODE disabled), the power dissipation will be set to the value inside register 98 and LED will turn green.
 - **ModSelL:** when activated, the ModSelL input pin is forced “Low” by the host. The module responds to 2-wire serial communication commands and the LED indicator will turn green. In **ModSelL** mode you are able to use multiple pins on a single 2-wire interface bus. When ModSelL is “high”, the module will not respond to any 2-wire interface communication from the host and the LED status is put to “Toggle”.
 - **ResetL** will reset the transceiver module when the status is set to “low”.
 - **ModPrstL** is an indicator signal that reflects the module presence. It is “Low” when the module is inserted and “High” when the module is physically absent from the host.
 - **IntL** is an indicator signal that reflects a change in the module state when in “Low” state. The IntL signal is high after all set interrupts flags are read.

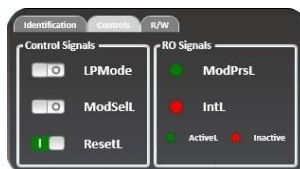

Figure 57: Controls tab of the CMIS window

- **R/W Tab** gives you access to MSA table banks. You can read or write the desired values under the Single Register tab. The data must be written in hexadecimal (HEX) format only.

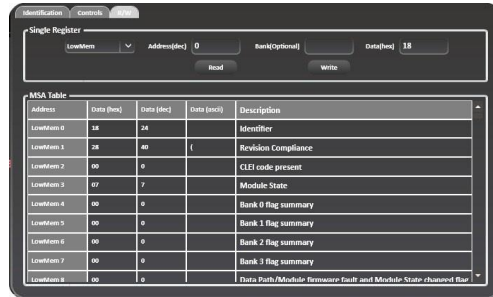

Figure 58: Read/write tab of CMIS window

When writing/reading data, the specified address should be less than 128 in the “LowMem” range and between 128 and 255 for higher memories. A pop-up message will warn you if these conditions are not adhered to.



Figure 59: Warning pop-up messages when the address access conditions were not adhered to

When the data is left empty, the following message will be displayed on the screen specifying an invalid data value:



Figure 60: Warning pop-up messages when the entered data is invalid

Transceiver Control

On the TX buttons for each channel, you can control the transceiver itself by configuring the output, polarity, squelch and equalization level. Subsequently on the RX side, you can configure Lane-Specific Control and Pre/Post-Cursor Equalization levels.



Figure 61: TX-side and RX-side configuration tabs

Adapter Measurements Bar

The Adapter Measurements Tab displays the V_{CC} , I_{VCC} of the module's alimention signal, of the transmission (TX) and the received (RX) signals.

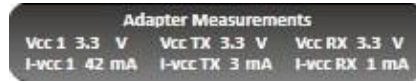

Figure 62: Adapter measurements bar

ML4054B Adapter

The built-in adapter of the ML4054 presents useful pins so you can directly access and control adapter features.

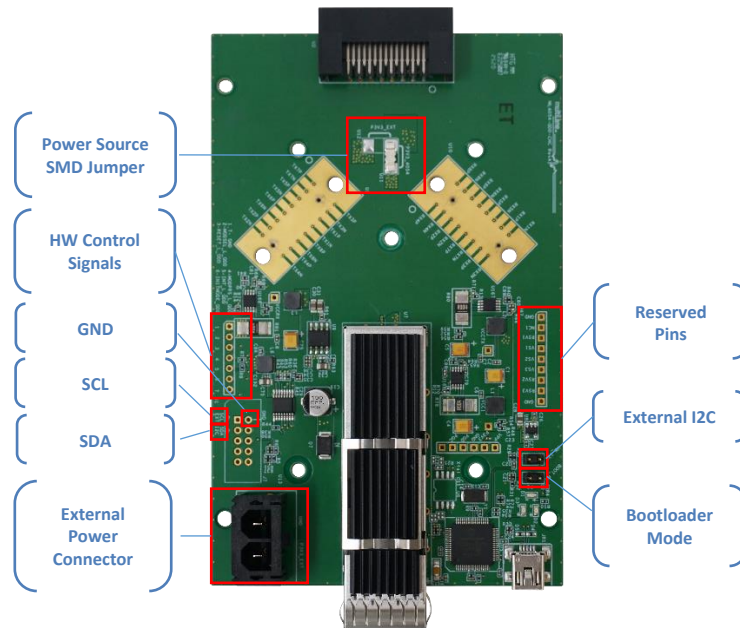



Figure 63: Adapter Board

PINS		Description	
Power Source SMD Jumper	<i>P3V3_EXT</i>	To enable external power mode, then SMD jumper must be placed on the <i>P3V3_EXT Pin</i> and power the adapter externally using the <i>External Power Connector</i> .	
	<i>P3V3_4054</i>	To power up the adapter from the 4054B platform, the jumper must be placed on the <i>P3V3_4054 Pin</i> .	
Hardware Control Signals	1, 7	GND	Ground
	2	MODSEL_L	Output Signal – Module to Host
	3	RESET_L	Input Signal – Host to Module
	4	MODPRSL	Input Signal – Host to Module
	5	INTL	Output Signal – Module to Host
	6	INITMODE	Input Signal – Host to Module

External Power Connector	When external power mode is enabled, the adapter should be powered using the external power pins (supply voltage should be 3.3 V) 
SCL	Serial Clock (SCL) Input Pin when operating in External I2C Mode.
SDA	Serial Data (SDA) Input Pin when operating in External I2C Mode.
GND	Ground Pin.
External I2C	To enable external I2C mode, a jumper should be placed on the <i>HW_I2C Pin</i> .
Bootloader Mode	To enable BOOT mode for firmware update.

Internal and External Mode I2C

You can toggle between internal and external I2C modes by using the adapter itself or via the ThunderBERT GUI. In external I2C mode, you will be allowed to communicate with the module by driving the adapter's I2C bus from an external source instead of direct communication between the board and the adapter.

In external I2C mode, you need to control the DUT using the I2C programmer:

- To enable a 2-wire communication, **MODESEL pin** should be grounded by connecting **Pin 1** and **Pin 2** using a jumper.
- To allow the operation in high power mode, **INITMODE pin** should be grounded by connecting **Pin 6** and **Pin 7** using a jumper.
- To read/control the “Hardware Control Signals” (RESET_L, MODEL, INTL), the corresponding pins (3 – 4 – 5) should be connected to the external source using wires.

Enabling External I2C Mode Using Adapter

To enable external I2C mode using the adapter, place a jumper on the **HW_I2C** pin shown in Figure 63.

Enabling External I2C Mode Using ThunderBERT

To enable external I2C mode, select the relevant checkbox within the “Additional Options” tab in ThunderBERT.

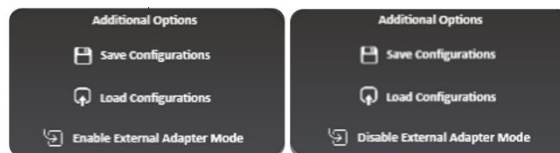

Figure 64: Additional Options Tab to enable/disable External Adapter Mode



Figure 65: Adapter measurements bar in external I2C operation mode

NOTES:

- If you attempt to enter internal I2C mode with the jumper still on the **HW_I2C pin**, a warning message will pop up (Figure 66).
- If the jumper is still on the **HW_I2C pin**, the adapter will operate in the external I2C mode regardless the chosen mode on the GUI.

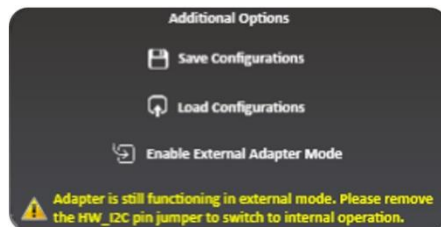



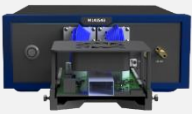





Figure 66: External mode disabled via the GUI while the jumper remains on the HW_I2C pin – the adapter will operate in external mode

BERT Characteristics

The MultiLane BERT family is diverse enough to cover a wide array of baud rates and specific applications. The key distinguishing characteristics of all ThunderBERT-compatible platforms can be found below. Detailed product specifications are available in the BERT section of the website [here](#).

Table 10: ThunderBERT Lineup Hardware Characteristics

Instrument PN	Channels	Max Baud Rate (GBd)	Max Amplitude (mVpp diff.)	Modulation	Platform-Specific Features
 ML4039B	4	28.125	800	PAM4/NRZ	<ul style="list-style-type: none"> Nearly-continuous line rate support from 1.12–1.56 GBd and 2.24–28.125 GBd
 ML4039D	4	29.5	1500	PAM4/NRZ	<ul style="list-style-type: none"> High amplitude swing 26 GBd-range RS-FEC Emulation
 ML4039E	4	58	800	PAM4/NRZ	<ul style="list-style-type: none"> High baud rate coverage 53 GBd-range Real HW RS-FEC (KP/KR)
 ML4039EN	4	58	800	PAM4/NRZ	<ul style="list-style-type: none"> High baud rate coverage 53 GBd-range Real HW RS-FEC (KP/KR) Noise Injection
 ML4054B	8	28.125	800	PAM4/NRZ	<ul style="list-style-type: none"> Continuous line rate support from 1.12–1.56 GBd and 2.24–28.125 GBd Built-in module adapter and embedded host GUI for QDD, OSFP or QSFP28 26 GBd-range Real HW RS-FEC (KP/KR)
 ML4079D	8	29.5	1500	PAM4/NRZ	<ul style="list-style-type: none"> High amplitude swing 26 GBd-range FEC Emulation for 50 Gbps, 100 Gbps and 200 Gbps stripes
 ML4079E	8	58	800	PAM4/NRZ	<ul style="list-style-type: none"> High baud rate coverage 53 GBd-range Real HW RS-FEC (KP/KR)
 ML4079EN	8	58	1500	PAM4/NRZ	<ul style="list-style-type: none"> High baud rate coverage and amplitude swing 53 GBd-range Real HW RS-FEC (KP/KR) Noise Injection

Appendix 1 – Adding a BERT to the Network

To create a local network connection, please follow these steps:

- **Create a local network connection** between the laptop and the BERT using Internet Protocol Version 4 (TCP/IPv4).
 - **Open Control Panel** and **choose Network and Internet**.
 - **Open Network and Sharing Center**.

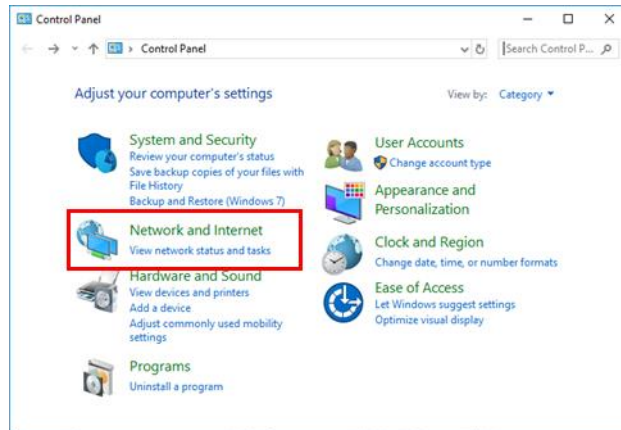

- **Click on Change Adapter Settings**, then **choose Local Area Connection**.

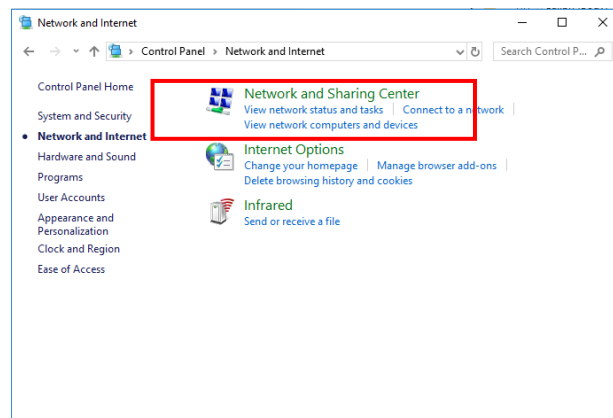

- In the Networking Tab, **click on Internet Protocol Version 4 (TCP/IPv4)** then **Properties**.

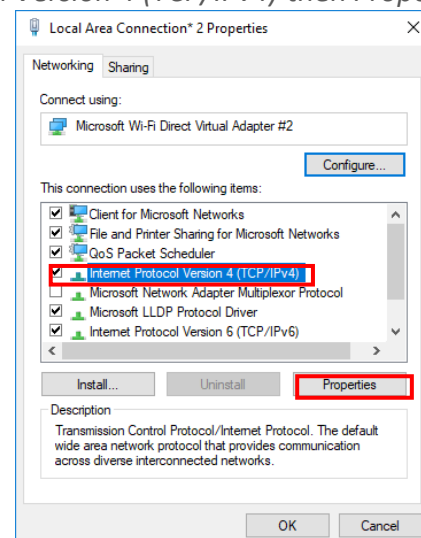
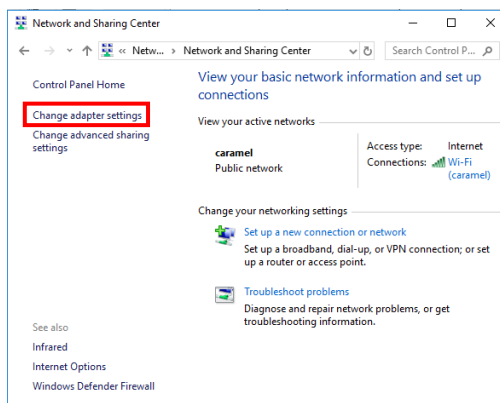

- **Add a similar IP Address** that shares a subnet with the instrument IP in the Advanced tab. This will be used to ping the instrument once the IP Address is changed to match that of the network.
- **Connect the laptop** directly to the BERT using an Ethernet cable.
- **Copy the IP Address** found on the back of the unit.
- **Ping the device** to make sure that the connection is successful.
- Now a new local network has been successfully defined.

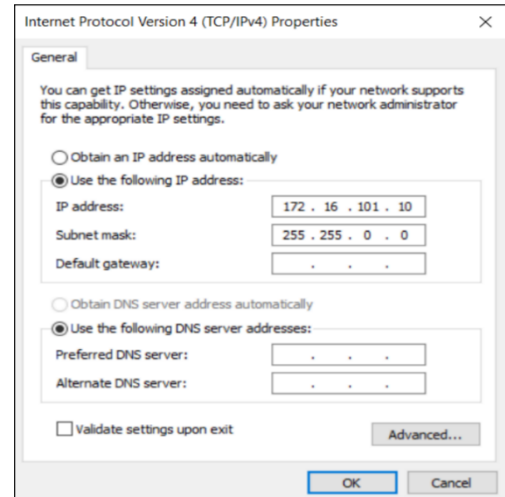

NOTES:

These steps are illustrated using Windows 10. Note that previous versions of Windows have a similar procedure with slight differences in tabs or folder names.

Appendix 2 – Changing the IP Address to Suit a Corporate Network

MultiLane does not recommend changing the IP address of the BERT instrument. However, this appendix will detail the steps for each operation.

Before starting the IP address change operation, please contact your IT department/support. You should be provided an available IP on the network. If the IP is the same as another device on the network, you can still ping the device but you will not be able to use it.

The process can be completed using [LaneControl GUI](#), using ethernet connection.

Follow the [LaneControl user guide](#) to install the GUI.

Note: IP addresses that begin with 169 will be considered not valid.

Changing the IP Address of the Instrument Using LaneControl

- **Follow** appendix 1 to add the BERT to the network
- **Launch** the LaneControl GUI
- **Connect** to the instrument using **Ethernet**
- **Scan** Ethernet Devices

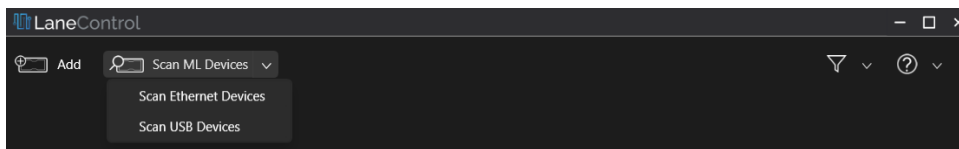

- **Choose** the instrument from the list of instruments that appear

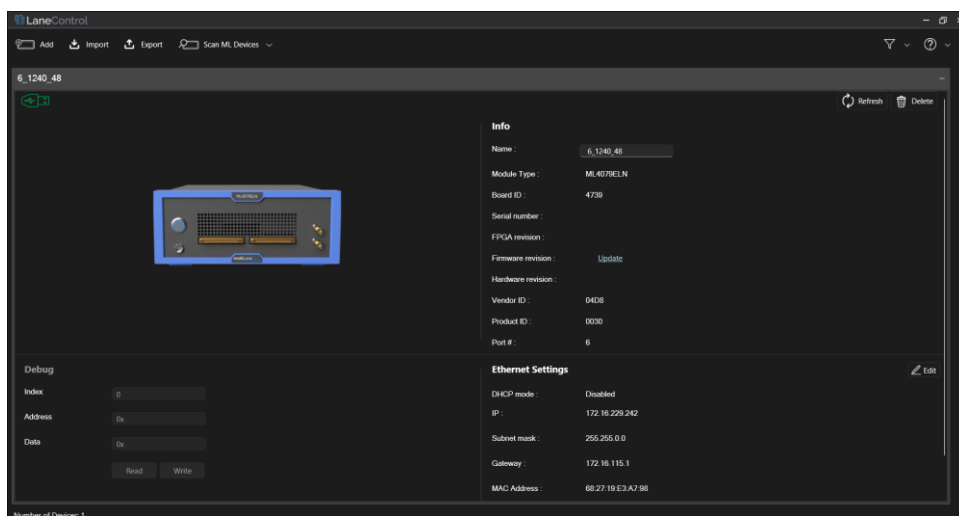

- **Edit** the device IP in the Ethernet Settings section

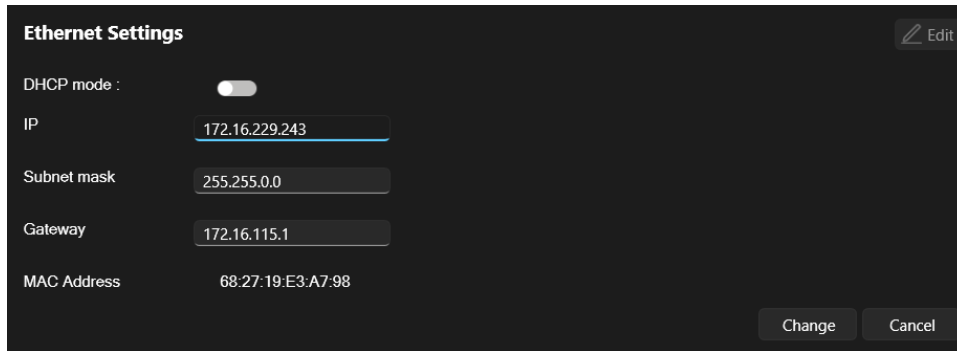

- **Click** Change
- **Power cycle** the instrument

Alternative way to add your instrument:

- **Add** an instrument manually through the Add window
- **Choose** on the left tree from the supported instruments

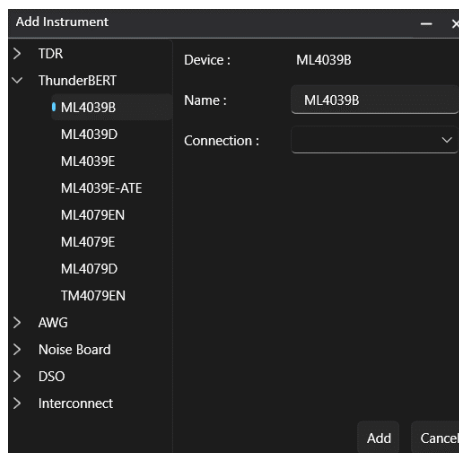

- **Choose** to connect through Ethernet
- **Provide** the IP address

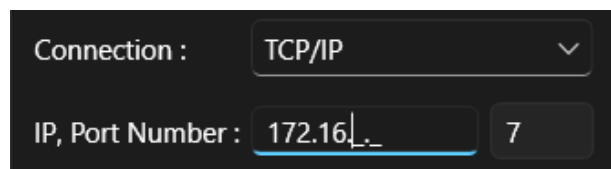

Appendix 3 – Firmware Upgrade: Step by Step Guide

The process can be completed using [LaneControl GUI](#), using USB connection.

Follow the [LaneControl user guide](#) to install the GUI.

Upgrading Firmware of the Instrument Using LaneControl

- **Launch** the LaneControl GUI
- **Connect** to the instrument using **USB**
- **Scan** USB Devices

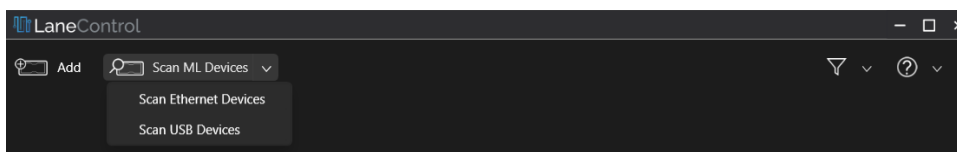

- **Choose** the instrument from the list of instruments that appear

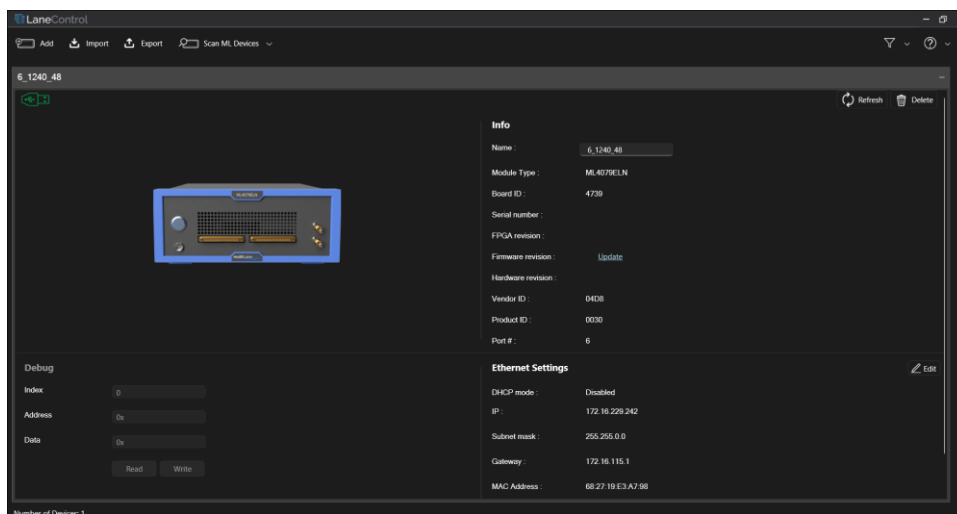

- **Click** Update in the Info section, next to Firmware revision



- **Read carefully** the instructions of the FWUpdateWizard
- **Select** “I have read and ensured FW update conditions are met”
- **Click** Next to proceed
- **Browse** for the .bin file of the new FW

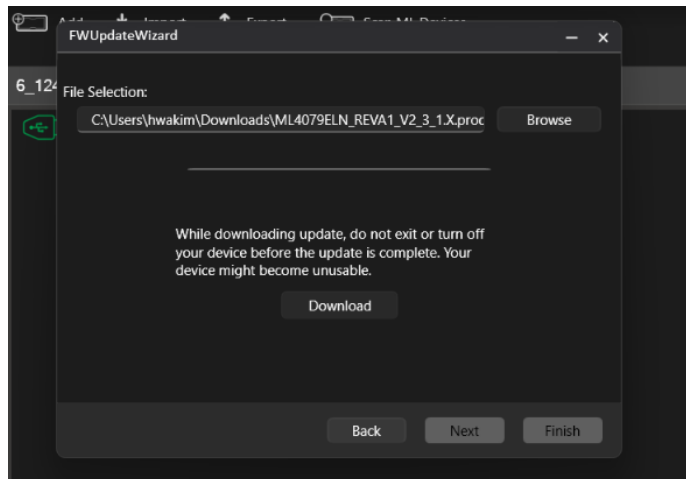

- **Click** Download
- **Click** Finish once the download is completed

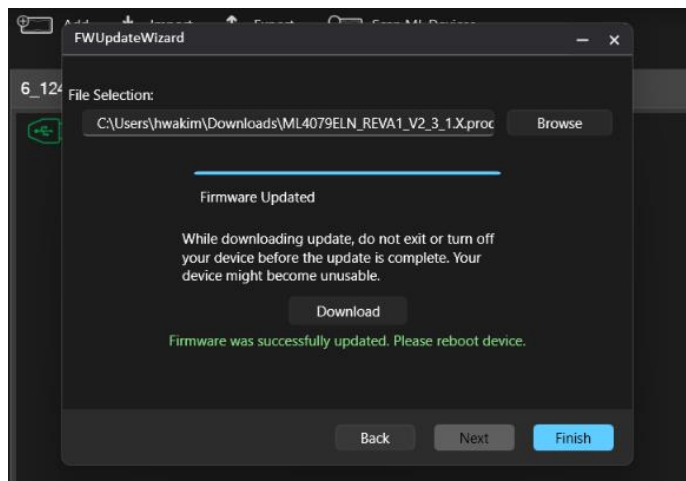

- **Power cycle** the instrument

For more information please contact our support team at: support@multilaneinc.com



North America

47073 Warm Springs Blvd.,
Fremont, CA 94539, USA
+1 510 573 6388

Worldwide

Houmal Technology Park
Askarieh Main Road
Houmal, Lebanon
+961 81 794 455

UAE

Building 4WA, Office 420
Dubai Airport Freezone Authority,
Dubai, UAE
+971 4 548 7 547